

8PIN 16 PIN ULTRA SMALL SSOP PHOTOTRANSISTOR PHOTOCOUPLER

Features:

- Halogens free
- Current transfer ratio
(CTR: 50~600% at $I_F = 5\text{mA}$, $V_{CE} = 5\text{V}$)
- High isolation voltage between input and output ($V_{iso} = 3750\text{ V rms}$)
- Compact 8 Pin SSOP with a 2.0 mm profile
- Pb free and RoHS compliant.
- UL approved (E214129)
- VDE approved (40028116)
- SEMKO approved
- NEMKO approved
- DEMKO approved
- FIMKO approved
- CQC approved

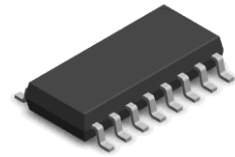
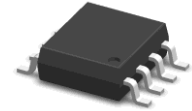

Description

The ELD3H7 and ELQ3H7 contains of an infrared emitting diode optically coupled to a phototransistor detector encapsulated with green compound.

ELD3H7 offers 2 channels in a 8-pin small outline SMD package, while ELQ3H7 offers 4 channels in a 16-pin small outline SMD package.

Applications

- DC-DC Converters
- Programmable controllers
- Telecommunication equipments
- Signal transmission between circuits of different potentials and impedances

Schematic

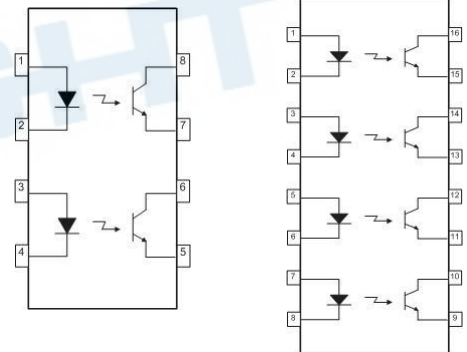

1, 3 Anode
2, 4 Cathode
5, 7 Emitter
6, 8 Collector

1, 3, 5, 7 Anode
2, 4, 6, 8 Cathode
9, 11, 13, 15 Emitter
10, 12, 14, 16 Collector

8PIN 16 PIN ULTRA SMALL SSOP PHOTOTRANSISTOR PHOTOCOUPLER

ELD3H7 ELQ3H7 Series

Absolute Maximum Ratings (T_a=25°C)

Parameter		Symbol	Rating	Unit
Input	Forward current	I _F	60	mA
	Peak forward current (1us, pulse)	I _{FP}	1	A
	Reverse voltage	V _R	6	V
	Power dissipation	P _D	70	mW
Output	Power dissipation	P _C	150	mW
	Collector current	I _C	50	mA
	Collector-Emitter voltage	V _{CEO}	80	V
	Emitter-Collector voltage	V _{ECO}	7	V
Total power dissipation		P _{TOT}	200	mW
Isolation voltage *1		V _{ISO}	3750	V rms
Operating temperature		T _{OPR}	-55 ~ +110	°C
Storage temperature		T _{STG}	-55 ~ +125	°C
Soldering temperature *2		T _{SOL}	260	°C

Notes

*1 AC for 1 minute, R.H.= 40 ~ 60% R.H. In this test, LED side pins shorted together, and detector side pins shorted together.

*2 For 10 seconds.

8PIN 16 PIN ULTRA SMALL SSOP PHOTOTRANSISTOR PHOTOCOUPLER

ELD3H7 ELQ3H7 Series

Electrical Characteristics (T_a=25°C unless specified otherwise)

Input

Parameter	Symbol	Min.	Typ.*	Max.	Unit	Condition
Forward voltage	V _F	-	1.2	1.4	V	I _F = 20mA
Reverse current	I _R	-	-	10	μA	V _R = 4V
Input capacitance	C _{in}	-	30	250	pF	V = 0, f = 1kHz

Output

Parameter	Symbol	Min.	Typ.*	Max.	Unit	Condition
Collector-Emitter dark current	I _{CEO}	-	-	100	nA	V _{CE} = 20V, I _F = 0mA
Collector-Emitter breakdown voltage	BV _{CEO}	80	-	-	V	I _C = 0.1mA
Emitter-Collector breakdown voltage	BV _{ECO}	7	-	-	V	I _E = 0.1mA

Transfer Characteristics (T_a=25°C unless specified otherwise)

Parameter	Symbol	Min.	Typ.*	Max.	Unit	Condition
Current Transfer ratio	CTR	50	-	600	%	I _F = 5mA, V _{CE} = 5V

Transfer Characteristics (T_a=25°C unless specified otherwise)

Parameter	Symbol	Min.	Typ.*	Max.	Unit	Condition
Collector-Emitter saturation voltage	V _{CE(sat)}	-	0.1	0.2	V	I _F = 10mA, I _C = 1mA
Isolation resistance	R _{IO}	5×10 ¹⁰	-	-	Ω	V _{IO} = 500Vdc, 40~60% R.H.
Floating capacitance	C _{IO}	-	0.3	1.0	pF	V _{IO} = 0, f = 1MHz
Rise time	t _r	-	5	18	μs	V _{CE} = 2V, I _C = 2mA, R _L = 100Ω
Fall time	t _f	-	3	18	μs	

* Typical values at T_a = 25°C

8PIN 16 PIN ULTRA SMALL SSOP PHOTOTRANSISTOR PHOTOCOUPLER

ELD3H7 ELQ3H7 Series

Typical Performance Curves

Figure 1. Forward Current vs Forward Voltage

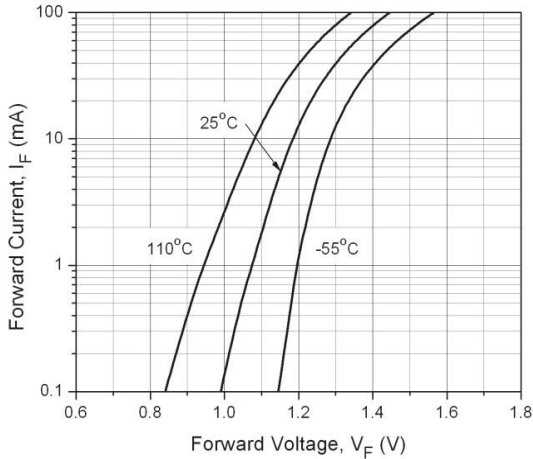

Figure 2. Normalized Collector Current vs Forward Current

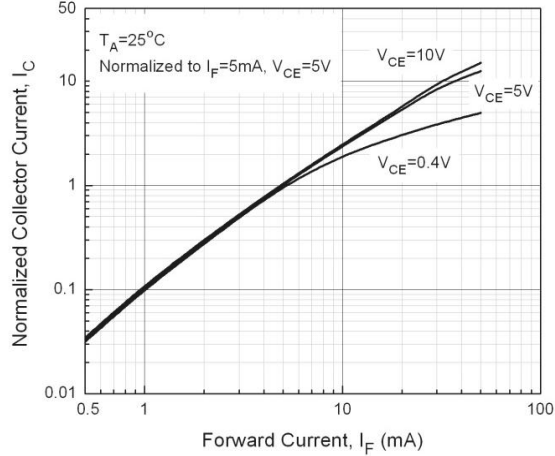

Figure 3. Normalized Current Transfer Ratio vs Forward Current

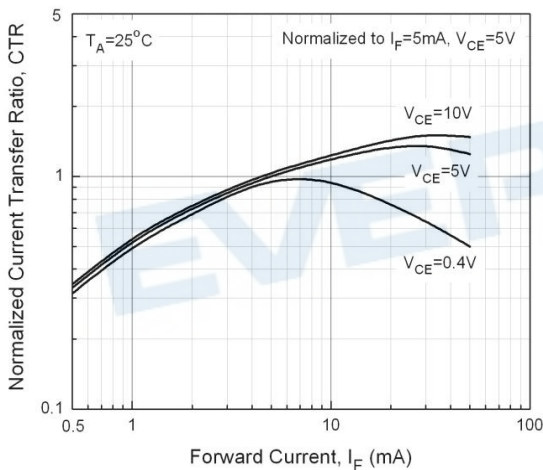

Figure 4. Normalized Collector Current vs Ambient Temperature

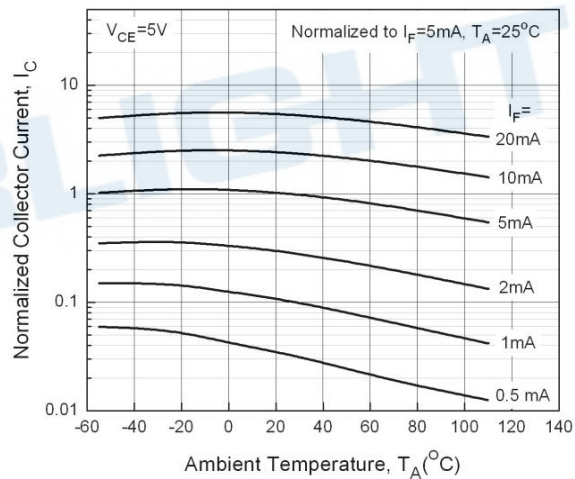

Figure 5. Normalized Current Transfer Ratio vs Ambient Temperature

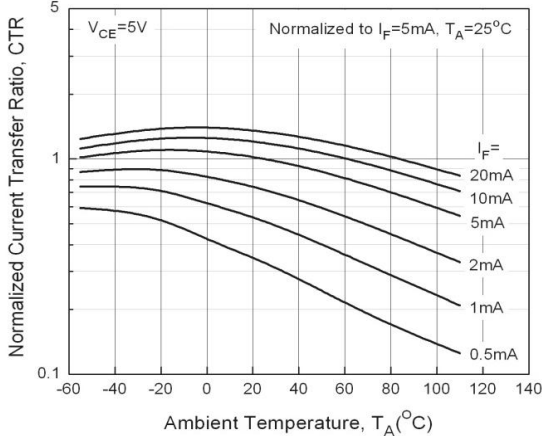
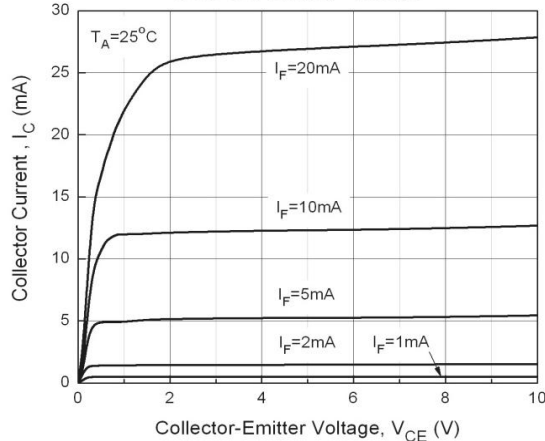

Figure 6. Collector Current vs Collector-Emitter Voltage



8PIN 16 PIN ULTRA SMALL SSOP PHOTOTRANSISTOR PHOTOCOUPLER

ELD3H7 ELQ3H7 Series

Figure 7. Collector Current vs Collector-Emitter Voltage

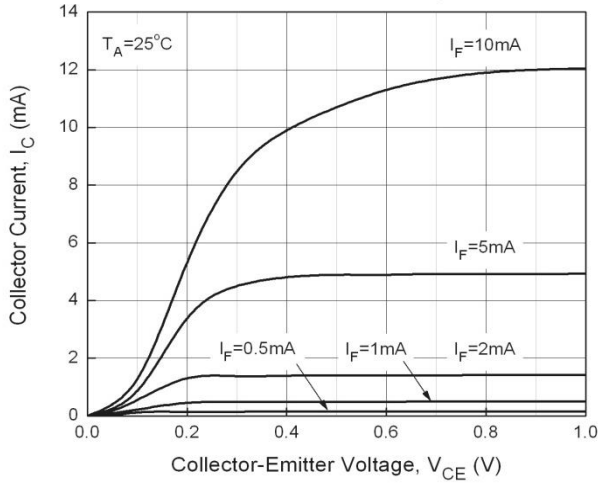

Figure 8. Collector Dark Current vs Ambient Temperature

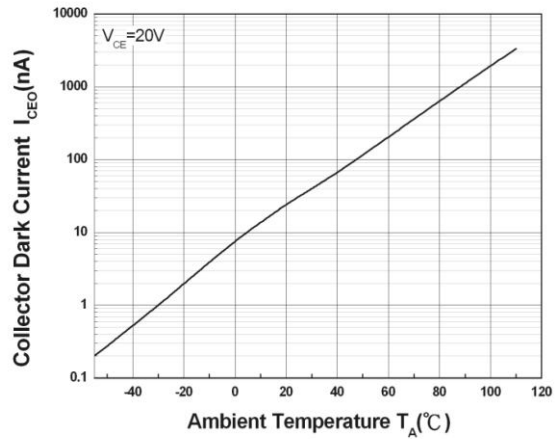

Figure 9. Collector-Emitter Saturation Voltage vs Ambient Temperature

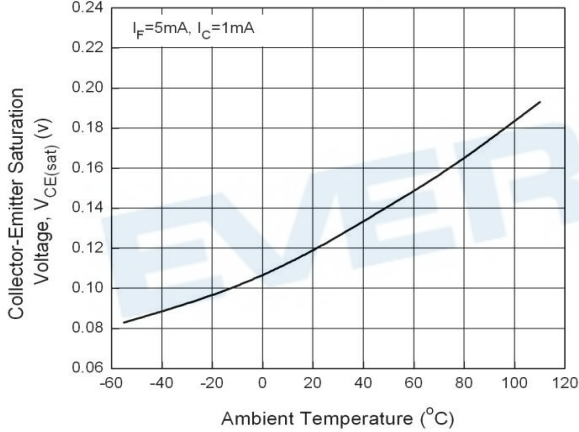

Figure 10. Switching Time vs Load Resistance

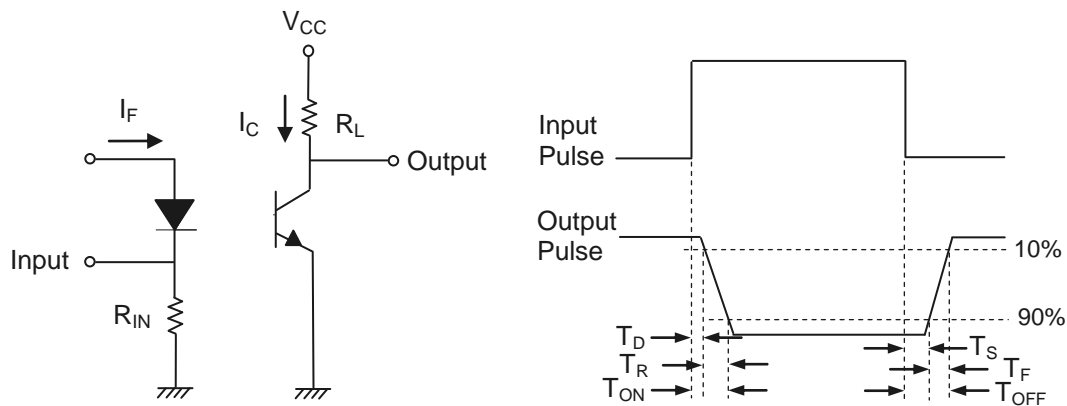
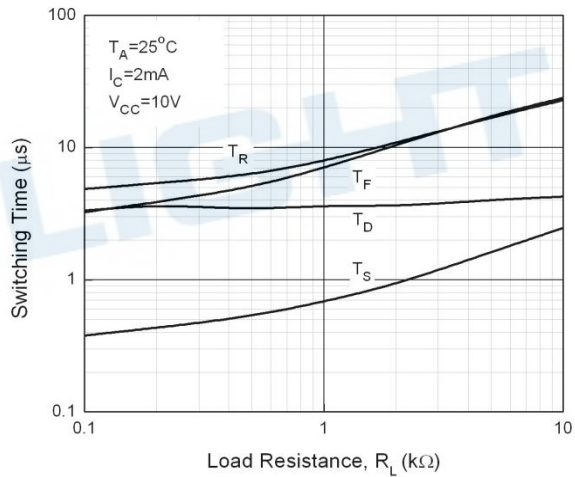

Figure 11. Switching Time Test Circuit & Waveforms

8PIN 16 PIN ULTRA SMALL SSOP PHOTOTRANSISTOR PHOTOCOUPLER

Order Information

Part Number

ELD3H7(Z)-V, ELQ3H7(Z)-V

Note

D3H7, Q3H7 = Part No.

Z = Tape and reel option (TA or none).

V = VDE (optional)

Option	Description	Packing quantity
None	Tube option of ELD3H7	80 units per tube
(TA)	Tape & reel option of ELD3H7	1000 units per reel
None	Tube option of ELQ3H7	40 units per tube
(TA)	Tape & reel option of ELQ3H7	1000 units per reel

8PIN 16 PIN ULTRA SMALL SSOP PHOTOTRANSISTOR PHOTOCOUPLER

ELD3H7 ELQ3H7 Series

Package Drawing

(Dimensions in mm)

ELD3H7

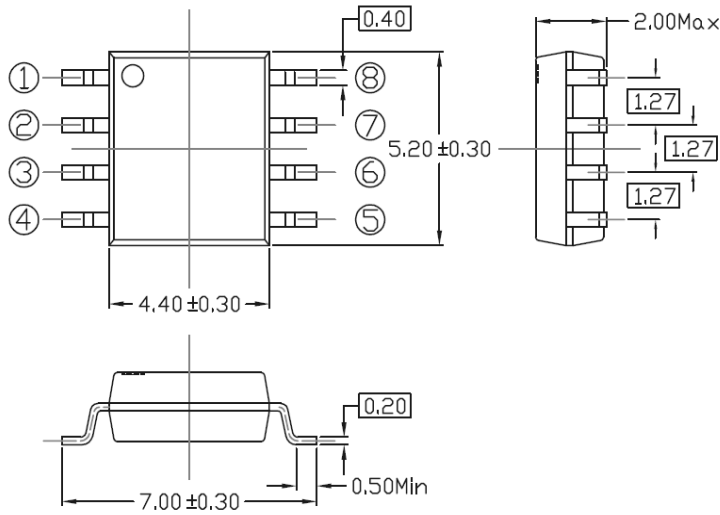

ELQ3H7

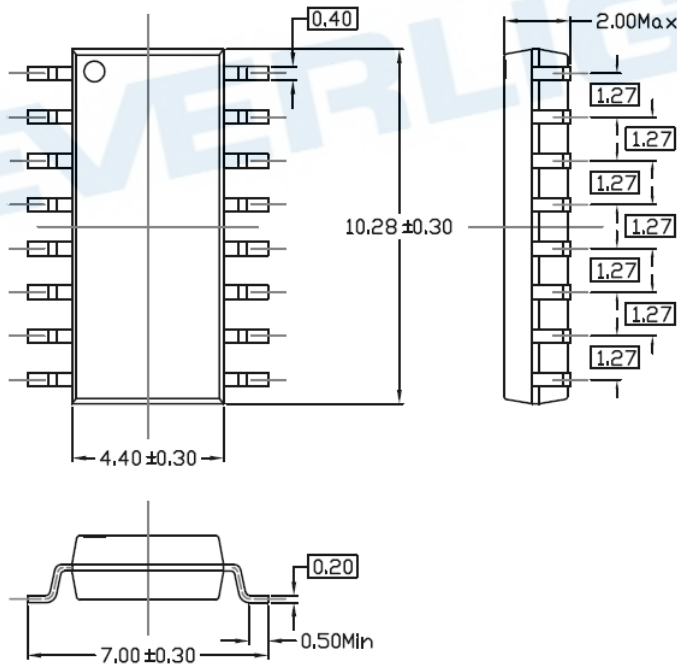

8PIN 16 PIN ULTRA SMALL SSOP PHOTOTRANSISTOR PHOTOCOUPLER

ELD3H7 ELQ3H7 Series

Recommended pad layout for surface mount leadform

ELD3H7

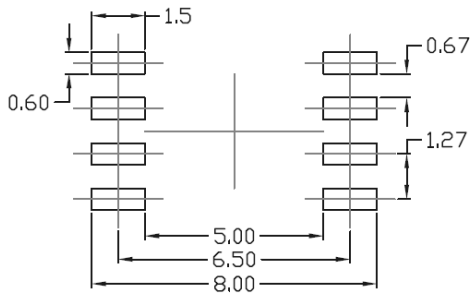

ELQ3H7

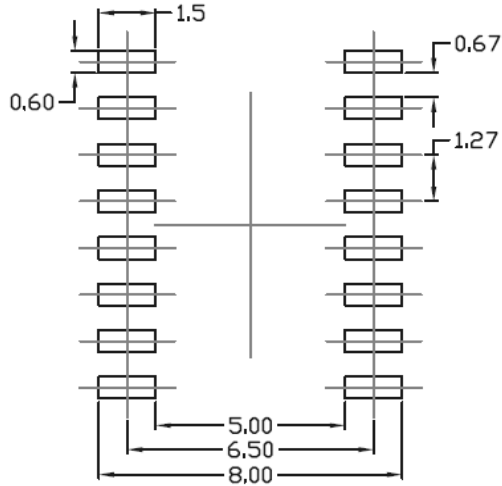

Device Marking

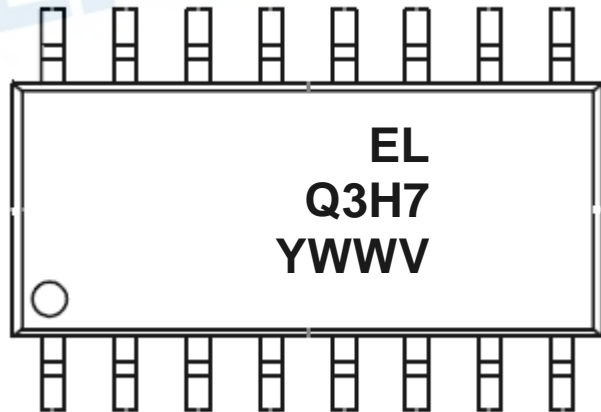

Notes

EL denotes Everlight
 Q3H7 D3H7 denotes Device Number
 Y denotes 1 digit Year code
 WW denotes 2 digit Week code
 V denotes VDE (optional)

8PIN 16 PIN ULTRA SMALL SSOP PHOTOTRANSISTOR PHOTOCOUPLER

ELD3H7 ELQ3H7 Series

Tape & Reel Packing Specifications

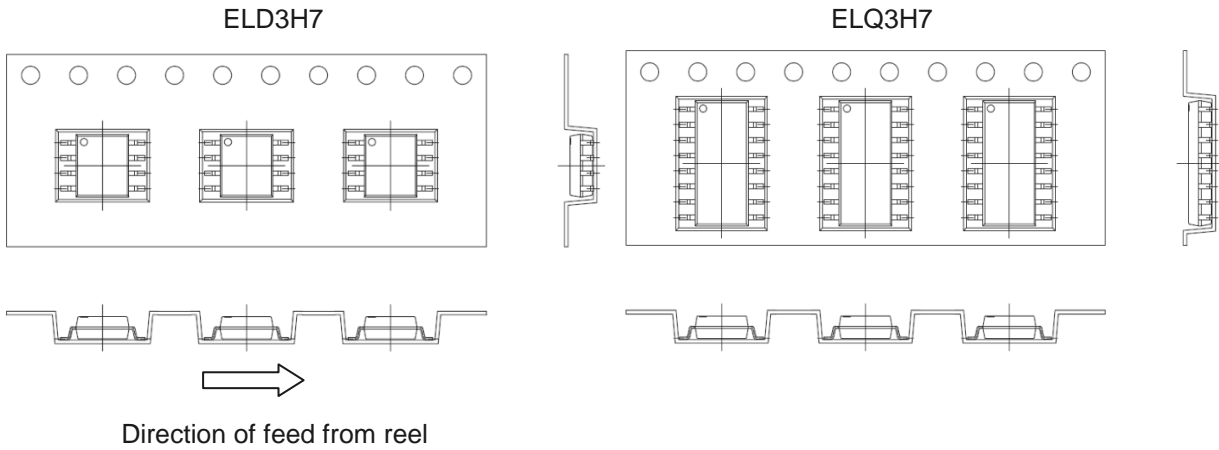

Tape dimensions

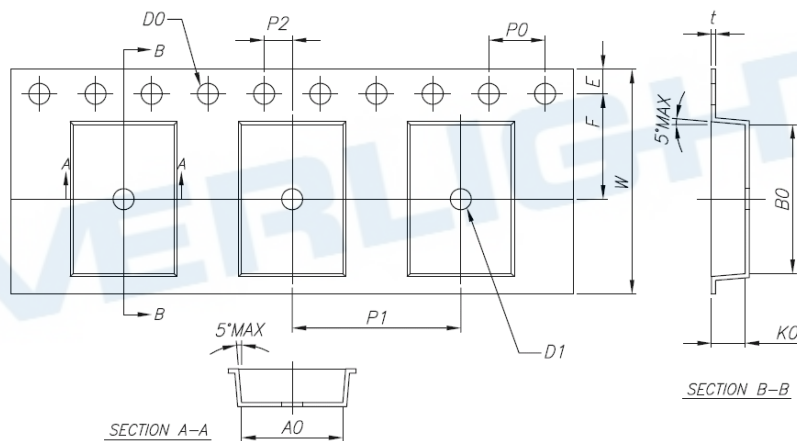

Dimension No.		A0	B0	D0	D1	E	F
Dimension (mm)	D3H7	7.4±0.1	5.6±0.1	1.5+0.1 -0	1.5+0.1 -0	1.75±0.1	7.5±0.1
	Q3H7	7.2±0.1	10.6±0.1	1.5+0.1 -0	1.5+0.1 -0	1.75±0.1	7.5±0.1
Dimension No.		P0	P1	P2	t	W	K0
Dimension (mm)	D3H7	4.0±0.1	12.0±0.1	2.0±0.1	0.3±0.05	16.0±0.3	2.4±0.1
	Q3H7	4.0±0.1	12.0±0.1	2.0±0.1	0.3±0.05	16.0±0.3	2.4±0.1

8PIN 16 PIN ULTRA SMALL SSOP PHOTOTRANSISTOR PHOTOCOUPLER

Solder Reflow Temperature Profile

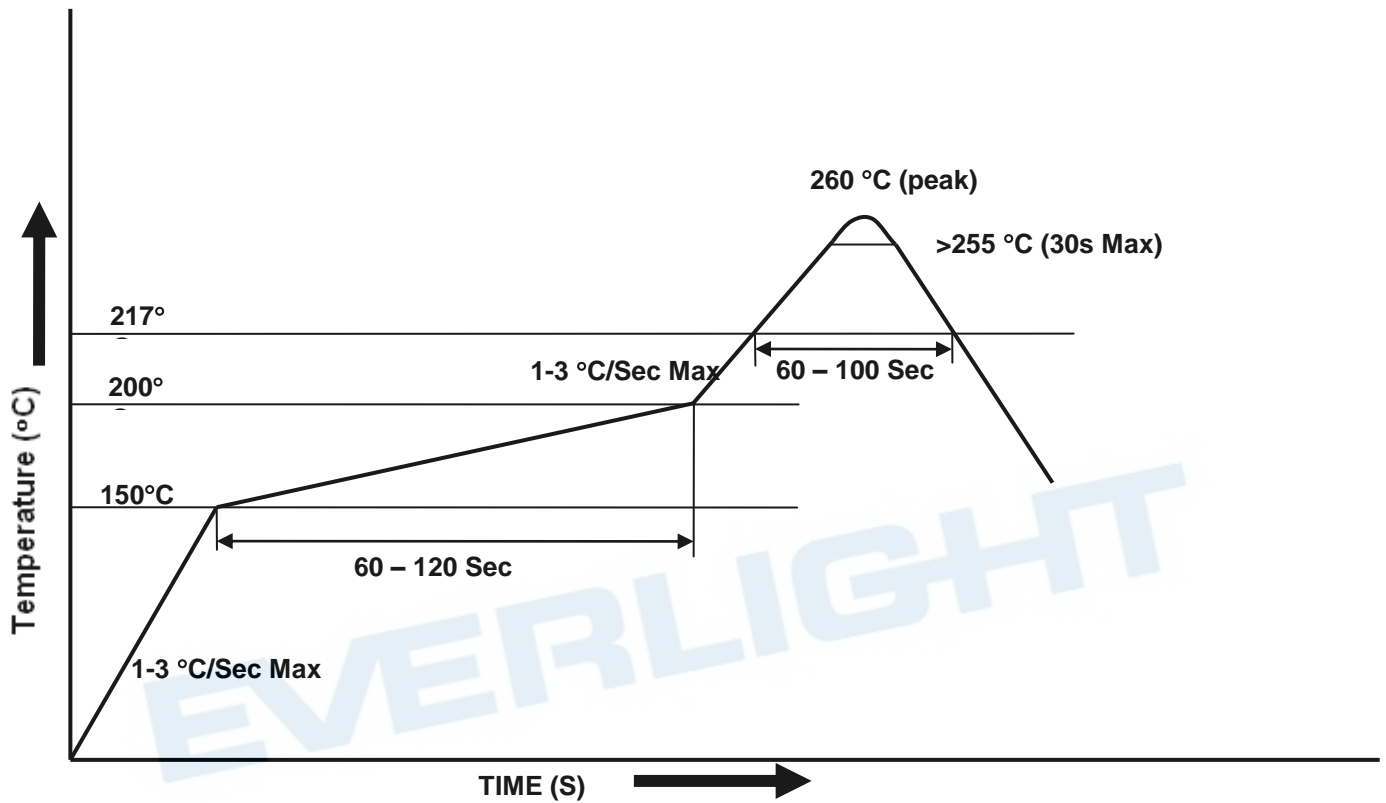

8PIN 16 PIN ULTRA SMALL SSOP PHOTOTRANSISTOR PHOTOCOUPLER

DISCLAIMER

1. The specifications in this datasheet may be changed without notice. EVERLIGHT reserves the authority on material change for above specification.
2. When using this product, please observe the absolute maximum ratings and the instructions for use as outlined in this datasheet. EVERLIGHT assumes no responsibility for any damage resulting from use of the product which does not comply with the absolute maximum ratings and the instructions included in this datasheet.
3. These specification sheets include materials protected under copyright of EVERLIGHT. Reproduction in any form is prohibited without the specific consent of EVERLIGHT.

EVERLIGHT