

◆ Features:

- ◇ High switching frequency
开关频率高
- ◇ Low forward voltage drop
正向压降低
- ◇ High efficiency and low power loss
高效低功耗
- ◇ High volume of current and good capability of surge current
大电流浪涌能力强

◆ Applications

- ◇ High frequency rectifier of switching mode power supplies
高频整流器开关电源
- ◇ Freewheeling diodes
续流二极管
- ◇ Polarity protection application
极性保护应用
- ◇ DC-DC converters
直流-直流变换器

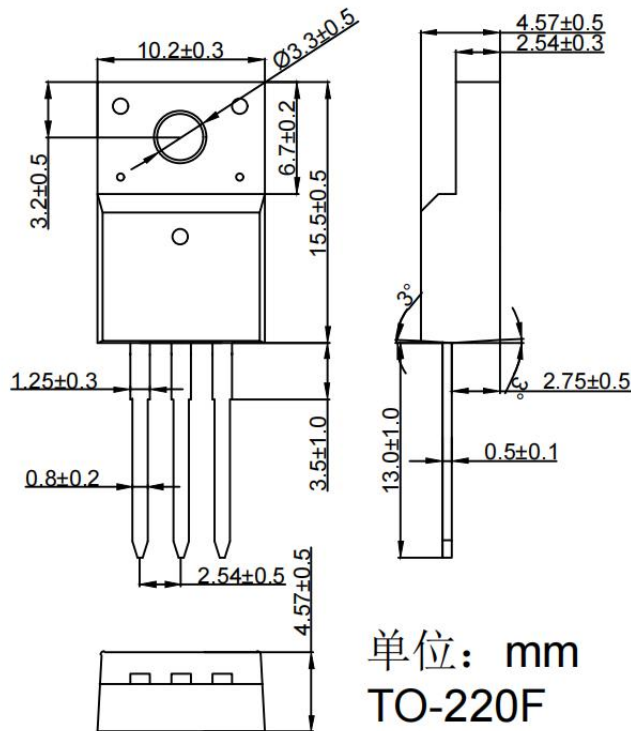
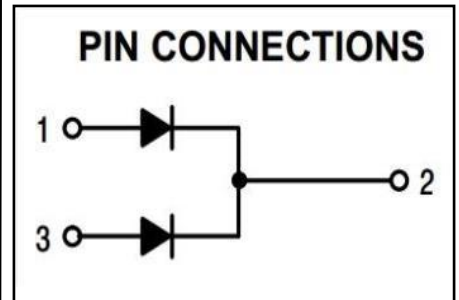
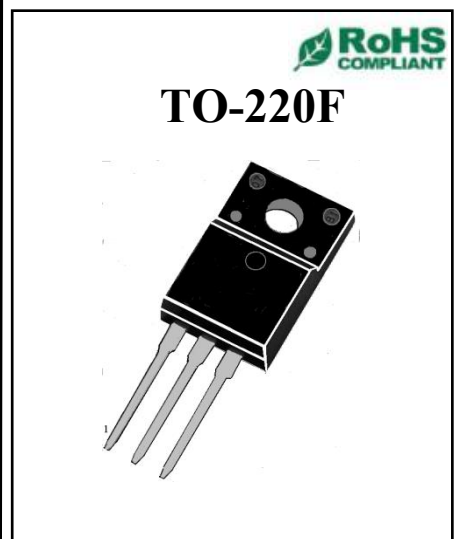

◆ Absolute Maximum Ratings (Tc=25°C)

Symbol	Parameters	Ratings	Unit
V _{RRM}	Repetitive Peak Reverse Voltage 最大反向重复峰值电压	200	V
V _{RWM}	Working peak reverse voltage 反向峰值工作电压	200	V
V _R	Maximum DC blocking voltage 最大直流反向电压	200	V
I _{F(AV)}	Maximum average forward rectified current Total device 最大正向平均电流	20	A
I _{FSM}	Peak Forward Surge Current 正向峰值浪涌电流	150	A
T _J	Operating junction temperature range 结温	175	°C
T _{stg}	Storage temperature range 贮存温度	-55~175	°C

◆ Electrical characteristics

Symbol	Parameters	Min	Typical	Max	Units	Conditions
I _R	Maximum Reverse Leakage Current (Note 1) 最大反向瞬态电流	--	--	10	uA	V _R =V _{RRM} T _C = 25 °C
V _F	Maximum Instantaneous Forward Voltage (Note 2) 最大瞬态正向压降	--	0.87	--	V	I _F = 10 A, T _C = 25 °C
R _{th(j-c)}	Typical Thermal Resistance, Junction to Case 结到外壳的典型热阻	--	--	2.5	°C/W	
dV/dt	Voltage Rate of Change 电压变化率	--	--	10000	V/μs	

Note 1: 2.0uS Pulse Width, f=1.0KHz

Note 2: Pulse Test : 300us Pulse Width, 1% Duty Cycle