

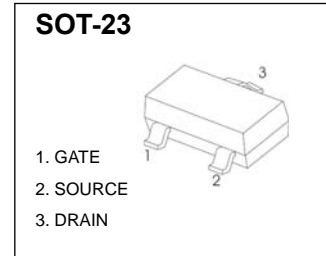

**SOT-23 Plastic-Encapsulate MOSFETS**

**CJ3415** P-Channel 20-V(D-S) MOSFET

$V_{(BR)DSS}$	$R_{DS(on)MAX}$	$I_D$
-20V	50mΩ@-4.5V	-4A
	60mΩ@-2.5V	
	100mΩ@-1.8V	



**FEATURE**

- Excellent  $R_{DS(ON)}$ , low gate charge, low gate voltages

**APPLICATION**

- Load switch and in PWM applications

**MARKING**

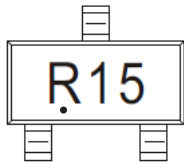

R15=Device code  
Solid dot = Green molding compound device.

**Equivalent Circuit**

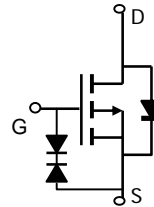

**Maximum ratings ( $T_a=25^\circ\text{C}$  unless otherwise noted)**

Parameter	Symbol	Value	Unit
Drain-Source Voltage	$V_{DS}$	-20	V
Gate-Source Voltage	$V_{GS}$	$\pm 8$	
Continuous Drain Current ( $t \leq 10s$ )	$I_D$	-4.0	A
Maximum Power Dissipation (note4)	$P_D$	1.3	W
Thermal Resistance from Junction to Ambient(note4)	$R_{\theta JA}$	96.2	$^\circ\text{C/W}$
Operation Junction and Storage Temperature Range	$T_J, T_{STG}$	-55 ~ +150	$^\circ\text{C}$

# MOSFET ELECTRICAL CHARACTERISTICS

$T_a=25^\circ\text{C}$  unless otherwise specified

Parameter	Symbol	Test Condition	Min	Typ	Max	Units
<b>Static Parameters</b>						
Drain-source breakdown voltage	$V_{(BR)DSS}$	$V_{GS} = 0V, I_D = -250\mu A$	-20			V
Gate threshold voltage	$V_{GS(th)}$	$V_{DS} = V_{GS}, I_D = -250\mu A$	-0.3	-0.56	-1	
Gate-body leakage current	$I_{GSS}$	$V_{DS} = 0V, V_{GS} = \pm 8V$			$\pm 10$	$\mu A$
		$V_{DS} = 0V, V_{GS} = \pm 4.5V$			$\pm 1$	
Zero gate voltage drain current	$I_{DSS}$	$V_{DS} = -16V, V_{GS} = 0V$			-1	
Drain-source on-state resistance(note1)	$R_{DS(on)}$	$V_{GS} = -4.5V, I_D = -4A$		0.037	0.050	$\Omega$
		$V_{GS} = -2.5V, I_D = -4A$		0.045	0.060	
		$V_{GS} = -1.8V, I_D = -2A$		0.080	0.100	
Forward transconductance(note2)	$g_{FS}$	$V_{DS} = -5V, I_D = -4A$	8			S
Body diode voltage(note2)	$V_{SD}$	$I_S = -1A, V_{GS} = 0V$			-1	V
<b>Dynamic Parameters (note3)</b>						
Input capacitance	$C_{iss}$	$V_{DS} = -10V, V_{GS} = 0V, f = 1MHz$		1450		$\mu F$
Output capacitance	$C_{oss}$			205		
Reverse transfer capacitance	$C_{rss}$			160		
Gate resistance	$R_g$	$V_{DS} = 0V, V_{GS} = 0V, f = 1MHz$		6.5		$\Omega$
<b>Switching Parameters</b>						
Total gate charge	$Q_g$	$V_{DS} = -10V, V_{GS} = -4.5V, I_D = -4A$		17.2		nC
Gate-Source charge	$Q_{gs}$			1.3		
Gate-drain charge	$Q_{gd}$			4.5		
Turn-on delay time (note3)	$t_{d(on)}$	$V_{DS} = -10V, V_{GS} = -4.5V$ $R_{GEN} = 3\Omega, R_L = 2.5\Omega,$		9.5		ns
Turn-on rise time(note3)	$t_r$			17		
Turn-off delay time(note3)	$t_{d(off)}$			94		
Turn-off fall time(note3)	$t_f$			35		

**Notes:**

1. Repetitive rating, pulse width limited by junction temperature.
2. Pulse Test : Pulse width  $\leq 300\mu s$ , duty cycle  $\leq 2\%$ .
3. These parameters have no way to verify.
4. Device mounted on 1"×1" FR-4 PCB with high coverage 2oz Copper ,double sided. Copper,  $t \leq 10s$ .

# Typical Characteristics

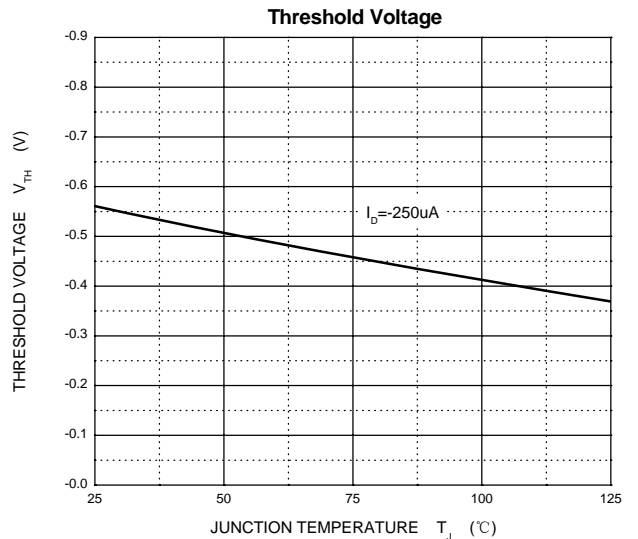
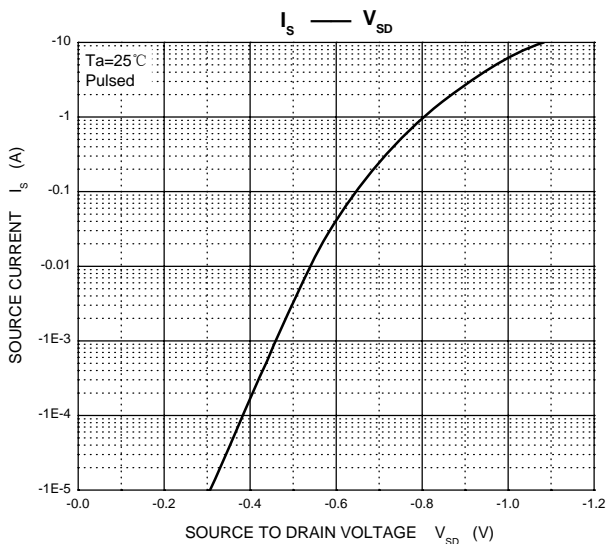
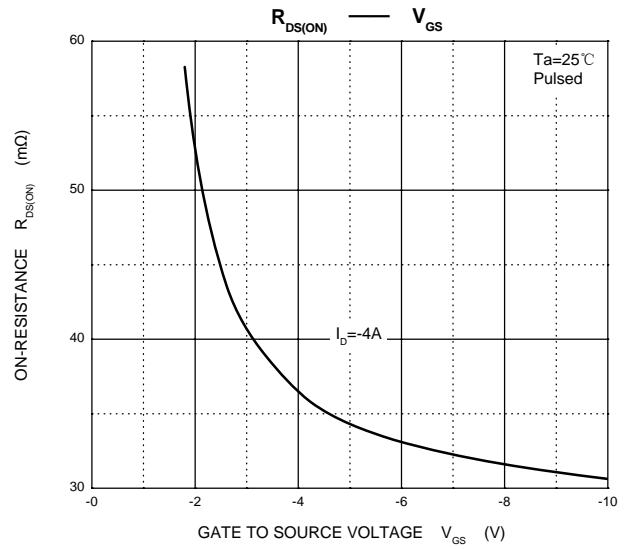
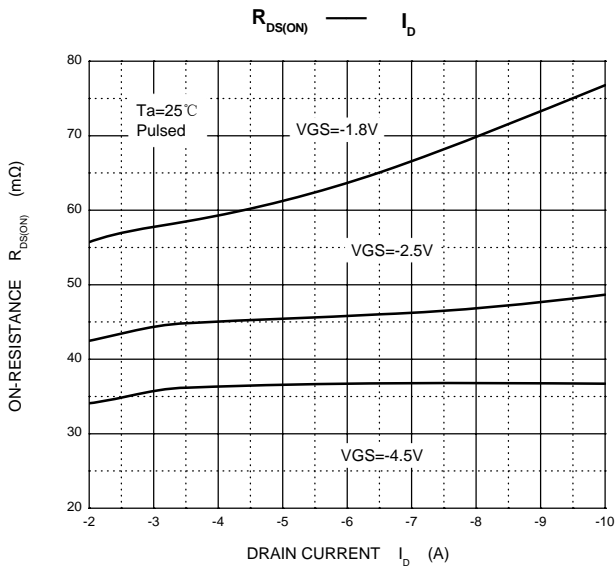
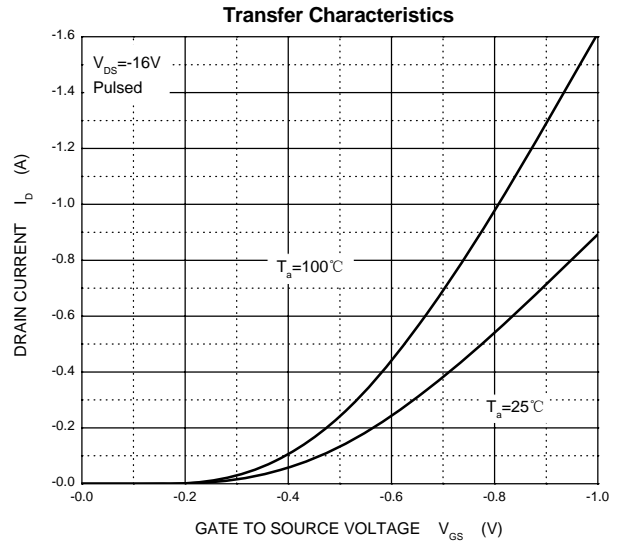
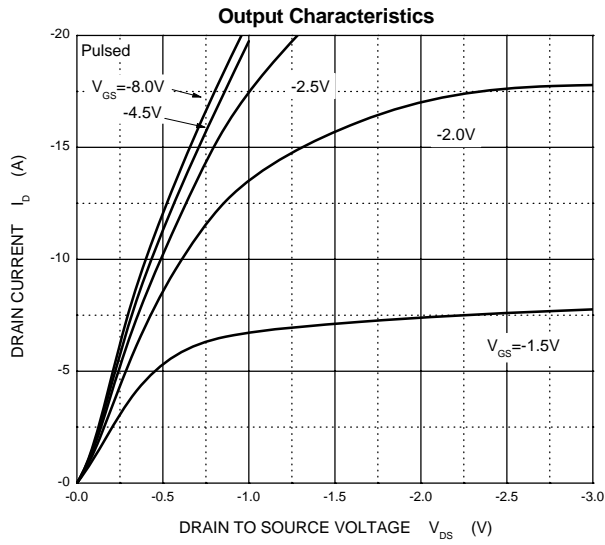

## SOT-23 Package Outline Dimensions

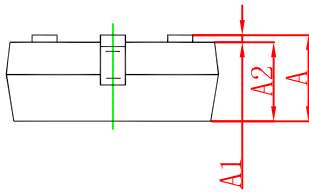
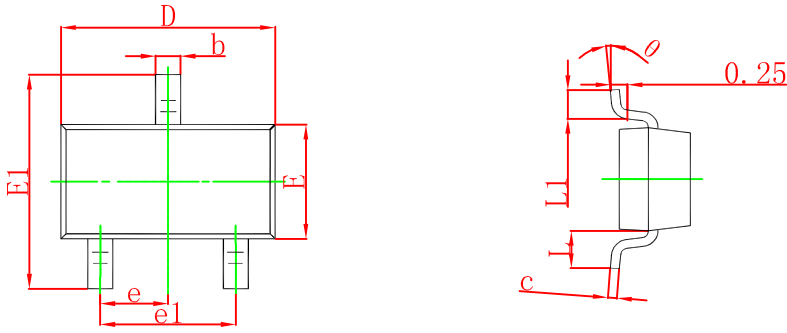

Symbol	Dimensions In Millimeters		Dimensions In Inches	
	Min	Max	Min	Max
A	0.900	1.150	0.035	0.045
A1	0.000	0.100	0.000	0.004
A2	0.900	1.050	0.035	0.041
b	0.300	0.500	0.012	0.020
c	0.080	0.150	0.003	0.006
D	2.800	3.000	0.110	0.118
E	1.200	1.400	0.047	0.055
E1	2.250	2.550	0.089	0.100
e	0.950 TYP		0.037 TYP	
e1	1.800	2.000	0.071	0.079
L	0.550 REF		0.022 REF	
L1	0.300	0.500	0.012	0.020
$\theta$	0°	8°	0°	8°

## SOT-23 Suggested Pad Layout

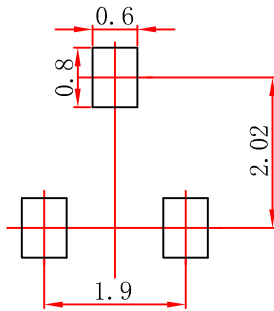

- Note:
1. Controlling dimension: in millimeters.
  2. General tolerance:  $\pm 0.05\text{mm}$ .
  3. The pad layout is for reference purposes only.

### NOTICE

JSCJ reserves the right to make modifications, enhancements, improvements, corrections or other changes without further notice to any product herein. JSCJ does not assume any liability arising out of the application or use of any product described herein.

# SOT-23 Tape and Reel

## SOT-23 Embossed Carrier Tape

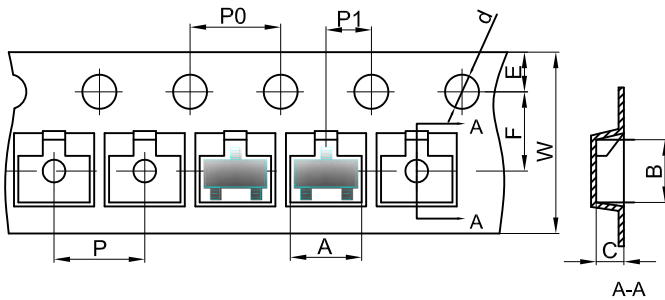

### Packaging Description:

SOT-23 parts are shipped in tape. The carrier tape is made from a dissipative (carbon filled) polycarbonate resin. The cover tape is a multilayer film (Heat Activated Adhesive in nature) primarily composed of polyester film, adhesive layer, sealant, and anti-static sprayed agent. These reeled parts in standard option are shipped with 3,000 units per 7" or 17.8cm diameter reel. The reels are clear in color and is made of polystyrene plastic (anti-static coated).

Dimensions are in millimeter

Pkg type	A	B	C	d	E	F	P0	P	P1	W
SOT-23	3.15	2.77	1.22	Ø1.50	1.75	3.50	4.00	4.00	2.00	8.00

## SOT-23 Tape Leader and Trailer

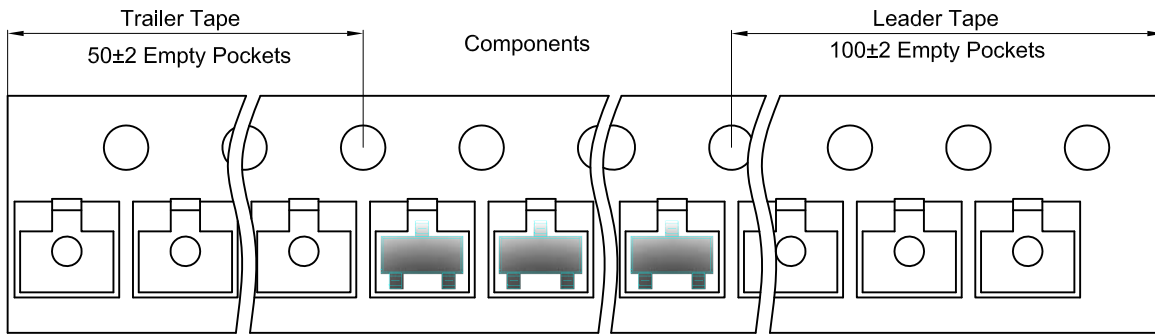

## SOT-23 Reel

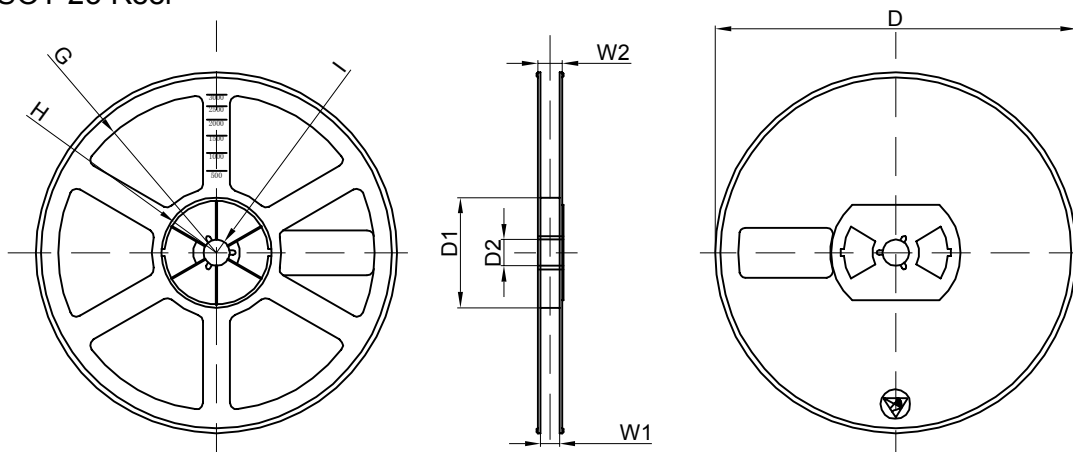

Dimensions are in millimeter

Reel Option	D	D1	D2	G	H	I	W1	W2
7"Dia	Ø178.00	54.40	13.00	R78.00	R25.60	R6.50	9.50	12.30

REEL	Reel Size	Box	Box Size(mm)	Carton	Carton Size(mm)	G.W.(kg)
3000 pcs	7 inch	30,000 pcs	203×203×195	120,000 pcs	438×438×220	