

Plastic-Encapsulate Diodes

ZENER DIODE

FEATURES

- Planar Die Construction
- Ultra-Small Surface Mount Package
- General purpose, Medium Current
- Ideally Suited for Automated Assembly Processes

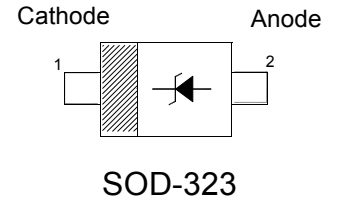

Maximum Ratings($T_a=25^{\circ}\text{C}$ unless otherwise specified)

Characteristic	Symbol	Value	Unit
Forward Voltage (Note 2) @ $I_F = 10\text{mA}$	V_F	0.9	V
Power Dissipation(Note 1)	P_d	200	mW
Thermal Resistance, Junction to Ambient Air	$R_{\theta JA}$	625	$^{\circ}\text{C}/\text{W}$
Operating and Storage Temperature Range	T_j, T_{STG}	-55~ +150	$^{\circ}\text{C}$

Notes:1. Device mounted on ceramic PCB; 7.6 mm x 9.4 mm x 0.87 mm with pad areas 25 mm².

2. Tested with pulses, $T_p \leq 1.0\text{ms}$.

Electrical Characteristics (T_a= 25°C unless otherwise specified)

Type Number	Code	Zener Voltage Range (Note 2)				Maximum Zener Impedance (Note 4)			Maximum Reverse Current	
		V _Z @I _{ZT}			I _{ZT}	Z _{ZT} @I _{ZT}	Z _{ZK} @I _{ZK}	I _{ZK}	I _R	V _R
		Nom(V)	Min(V)	Max(V)	mA	Ω		mA	uA	V
MMSZ5221BS	C1	2.4	2.28	2.52	20	30	1200	0.25	100	1.0
MMSZ5223BS	C3	2.7	2.57	2.84	20	30	1300	0.25	75	1.0
MMSZ5225BS	C5	3.0	2.85	3.15	20	30	1600	0.25	50	1.0
MMSZ5226BS	G1	3.3	3.14	3.47	20	28	1600	0.25	25	1.0
MMSZ5227BS	G2	3.6	3.42	3.78	20	24	1700	0.25	15	1.0
MMSZ5228BS	G3	3.9	3.71	4.10	20	23	1900	0.25	10	1.0
MMSZ5229BS	G4	4.3	4.09	4.52	20	22	2000	0.25	5	1.0
MMSZ5230BS	G5	4.7	4.47	4.94	20	19	1900	0.25	5	2.0
MMSZ5231BS	E1	5.1	4.85	5.36	20	17	1600	0.25	5	2.0
MMSZ5232BS	E2	5.6	5.32	5.88	20	11	1600	0.25	5	3.0
MMSZ5233BS	E3	6.0	5.70	6.30	20	7	1600	0.25	5	3.5
MMSZ5234BS	E4	6.2	5.89	6.51	20	7	1000	0.25	5	4.0
MMSZ5235BS	E5	6.8	6.46	7.14	20	5	750	0.25	3	5.0
MMSZ5236BS	F1	7.5	7.13	7.88	20	6	500	0.25	3	6.0
MMSZ5237BS	F2	8.2	7.79	8.61	20	8	500	0.25	3	6.5
MMSZ5238BS	F3	8.7	8.27	9.14	20	8	600	0.25	3	6.5
MMSZ5239BS	F4	9.1	8.65	9.56	20	10	600	0.25	3	7.0
MMSZ5240BS	F5	10	9.50	10.50	20	17	600	0.25	3	8.0
MMSZ5241BS	H1	11	10.45	11.55	20	22	600	0.25	2.0	8.4
MMSZ5242BS	H2	12	11.40	12.60	20	30	600	0.25	1.0	9.1
MMSZ5243BS	H3	13	12.35	13.65	9.5	13	600	0.25	0.5	9.9
MMSZ5244BS	H4	14	13.30	14.70	9.0	15	600	0.25	0.1	10
MMSZ5245BS	H5	15	14.25	15.75	8.5	16	600	0.25	0.1	11
MMSZ5246BS	J1	16	15.20	16.80	7.8	17	600	0.25	0.1	12
MMSZ5248BS	J3	18	17.10	18.90	7.0	21	600	0.25	0.1	14
MMSZ5250BS	J5	20	19.00	21.00	6.2	25	600	0.25	0.1	15
MMSZ5251BS	K1	22	20.90	23.10	5.6	29	600	0.25	0.1	17
MMSZ5252BS	K2	24	22.80	25.20	5.2	33	600	0.25	0.1	18
MMSZ5253BS	K3	25	23.75	26.25	5.0	35	600	0.25	0.1	19
MMSZ5254BS	K4	27	25.65	28.35	5.0	41	600	0.25	0.1	21
MMSZ5255BS	K5	28	26.60	29.40	4.5	44	600	0.25	0.1	21
MMSZ5256BS	M1	30	28.50	31.50	4.2	49	600	0.25	0.1	23
MMSZ5257BS	M2	33	31.35	34.65	3.8	58	700	0.25	0.1	25
MMSZ5258BS	M3	36	34.20	37.80	3.4	70	700	0.25	0.1	27
MMSZ5259BS	M4	39	37.05	40.95	3.2	80	800	0.25	0.1	30

Typical Characteristics

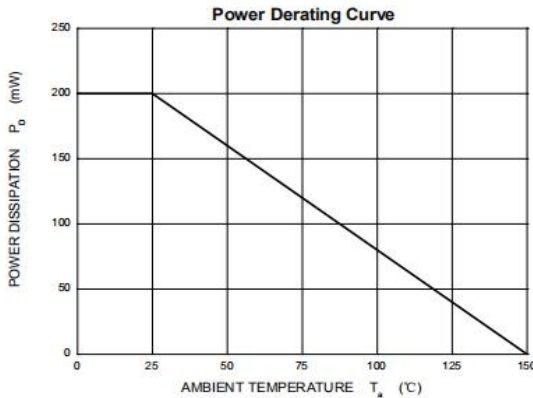
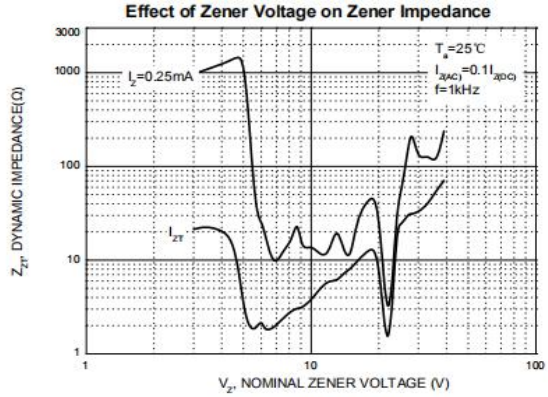
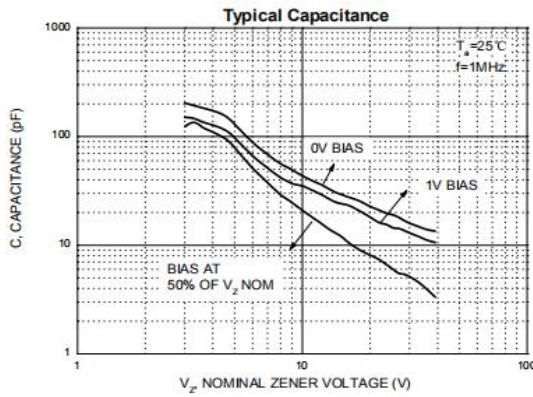
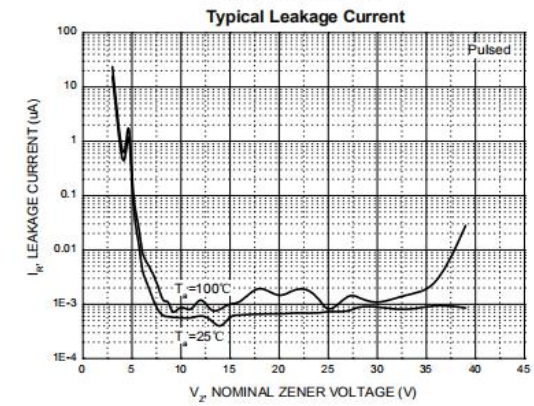
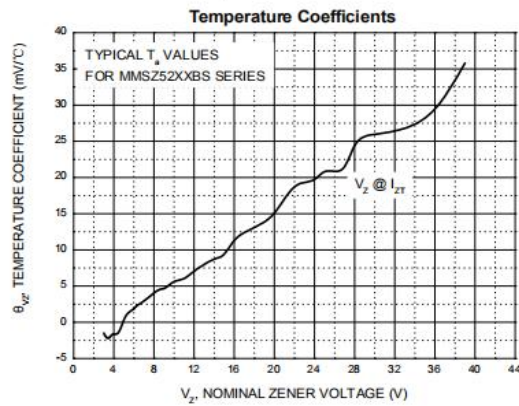
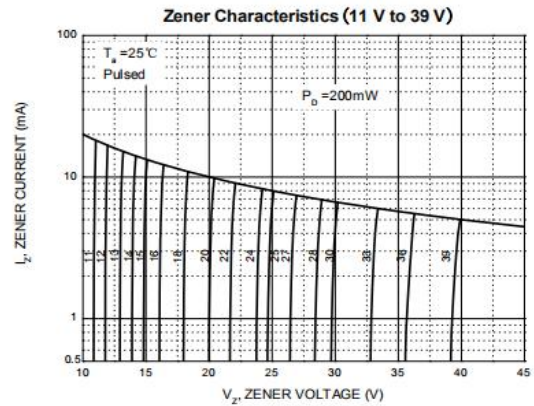
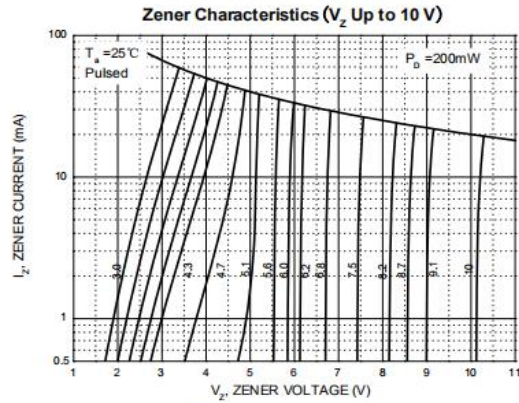

PACKAGE OUTLINE

Plastic surface mounted package; 2 leads

SOD 323

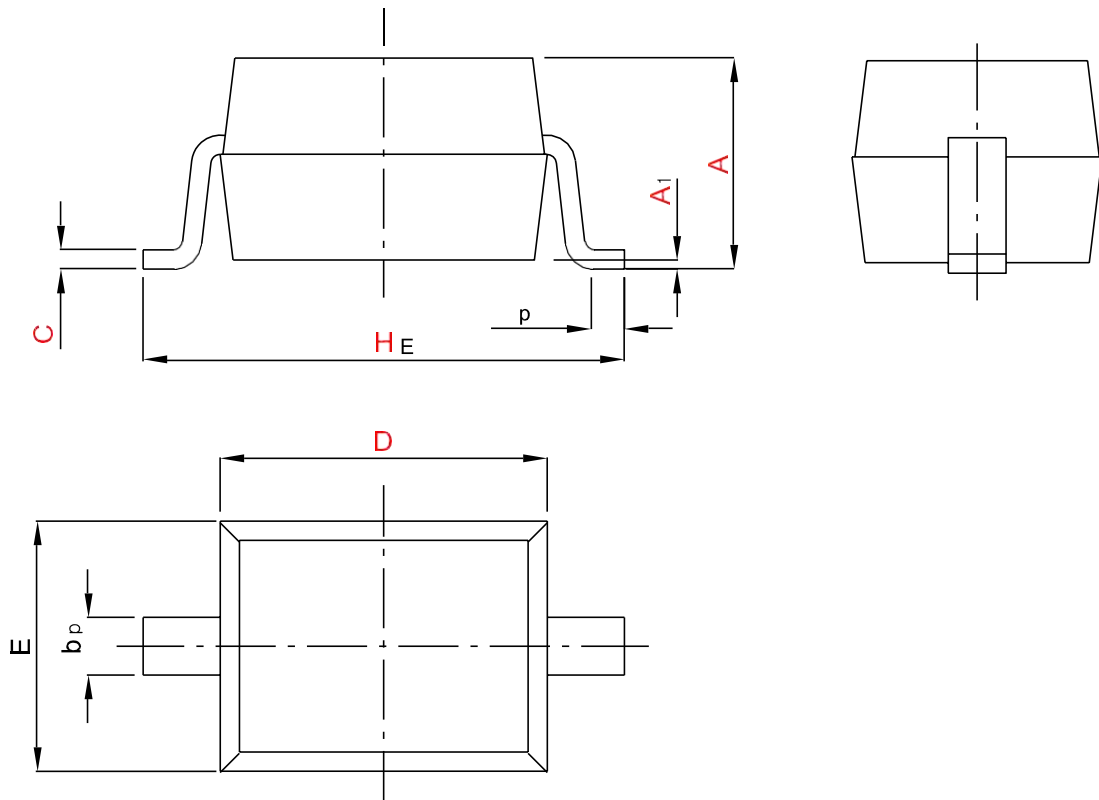

UNIT	A	bp	C	D	E	HE	A1	Lp
mm	1.20	0.40	0.15	1.80	1.35	2.80	0.10	0.50
	0.90	0.25	0.10	1.60	1.15	2.30	0.01	0.20

