

Description

The AP7343Q is a low dropout regulator with high output voltage accuracy, low $R_{DS(ON)}$, high PSRR, low output noise and low quiescent current. This regulator is based on a CMOS process.

The AP7343Q includes a voltage reference, error amplifier, current limit circuit, and an enable input to turn it on and off. With the integrated resistor network, fixed output voltage versions can be delivered.

With its low power consumption and line and load transient responses, the AP7343Q is well suited for noise sensitive automotive applications.

The AP7343Q is packaged in SOT25, W-DFN2020-6 (SWP) (Type A1), and W-DFN2020-6 (SWP) (Type UXD) packages, which allow for the smallest footprint and dense PCB layout.

Features

- Low V_{IN} and Wide V_{IN} Range: 1.7V to 5.25V
- -40°C to +125°C Temperature Range
- Guaranteed Output Current: 300mA
- V_{OUT} Accuracy $\pm 1\%$
- Ripple Rejection 75dB at 1kHz
- Low Output Noise, 60 μ Vrms from 10Hz to 100kHz
- Quiescent Current as Low as 35 μ A
- V_{OUT} Fixed 0.9V to 3.6V
- **Totally Lead-Free & Fully RoHS Compliant (Notes 1 & 2)**
- **Halogen and Antimony Free. "Green" Device (Note 3)**
- **The AP7343Q is suitable for automotive applications requiring specific change control; this part is AEC-Q100 qualified, PPAP capable, and manufactured in IATF 16949 certified facilities.**

<https://www.diodes.com/quality/product-definitions/>

- Notes:
1. No purposely added lead. Fully EU Directive 2002/95/EC (RoHS), 2011/65/EU (RoHS 2) & 2015/863/EU (RoHS 3) compliant.
 2. See <https://www.diodes.com/quality/lead-free/> for more information about Diodes Incorporated's definitions of Halogen- and Antimony-free, "Green" and Lead-free.
 3. Halogen- and Antimony-free "Green" products are defined as those which contain <900ppm bromine, <900ppm chlorine (<1500ppm total Br + Cl) and <1000ppm antimony compounds.

Typical Applications Circuit

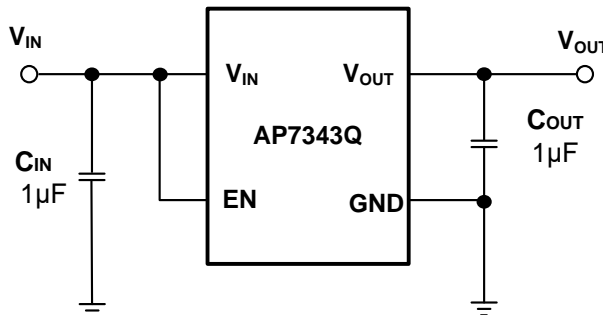

Pin Assignments

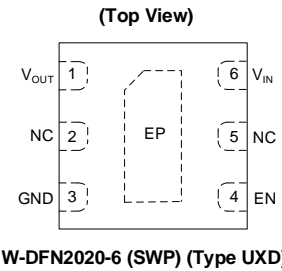
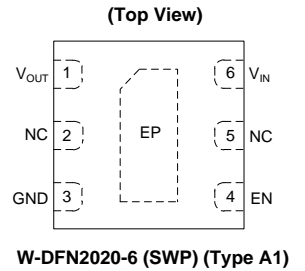
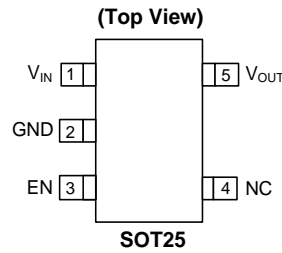

Applications

- Infotainment power supplies
- Automotive RF supplies
- Cameras
- Automotive POL in ADAS
- Automotive wireless communications

Pin Descriptions

Pin Number			Pin Name	Function
SOT25	W-DFN2020-6 (SWP) (Type A1)	W-DFN2020-6 (SWP) (Type UXD)		
1	6	6	V _{IN}	Power Input Pin
2	3	3	GND	Ground
3	4	4	EN	Enable Pin This pin must be driven either high or low and must not be floating. Driving this pin high enables the regulator, and pulling it low puts the regulator into shutdown mode.
4	2, 5	2, 5	NC	No Connect Not connected internally; recommended to connect to GND to maximize PCB copper for thermal dissipation.
5	1	1	V _{OUT}	Power Output Pin
—	EP	EP	Expose Pad	In PCB layout, prefer to use large copper area to cover this pad for better thermal dissipation, then connect this area to GND or leave it open. However, do not use it as GND electrode function alone.

Functional Block Diagram

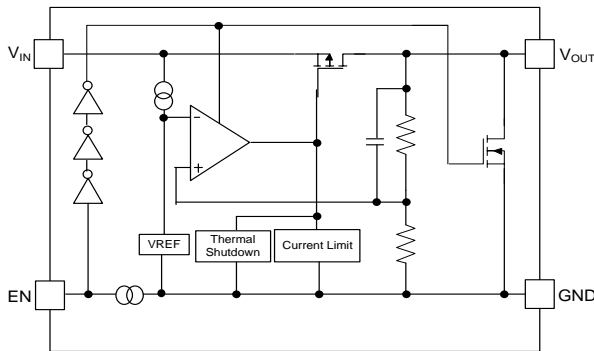

AP7343DQ (With Discharge)

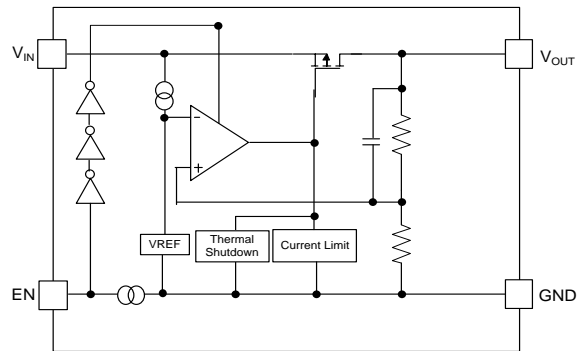

AP7343Q (Without Discharge)

Absolute Maximum Ratings (Note 4) (@T_A = +25°C, unless otherwise specified.)

Symbol	Parameter		Ratings	Unit
ESD HBM	Human Body Mode ESD Protection		> 2	kV
ESD CDM	Charge Device Model		±500	V
V _{IN}	Input Voltage		6.0	V
V _{EN}	Input Voltage for EN Pin		6.0	V
V _{OUT}	Output Voltage		-0.3 to V _{IN} + 0.3	V
I _{OUT}	Output Current		400	mA
P _D	Power Dissipation	SOT25	698	mW
		W-DFN2020-6 (SWP) (Type A1) (Wettable)	2314	
		W-DFN2020-6 (SWP) (Type UXD) (Wettable)	2345	
T _J	Operating Junction Temperature		-40 to +150	°C
T _{STG}	Storage Temperature		-55 to +150	°C

Note: 4. a). Stresses greater than those listed under *Absolute Maximum Ratings* can cause permanent damage to the device. These are stress ratings only, and functional operation of the device at these or any other conditions beyond those indicated under *Recommended Operating Conditions* is not implied. Exposure to *Absolute Maximum Ratings* for extended periods can affect device reliability.
 b). Ratings apply to ambient temperature at +25°C. The JEDEC High-K board design used to derive this data was a 2inch x 2inch multilayer board with 1oz internal power and ground planes and 2oz copper traces on the top and bottom of the board.

Recommended Operating Conditions (@T_A = +25°C, unless otherwise specified.)

Symbol	Parameter	Min	Max	Unit
V _{IN}	Input Voltage	1.7	5.25	V
I _{OUT}	Output Current	0	300	mA
T _J	Operating Junction Temperature	-40	+125	°C
T _A	Operating Ambient Temperature	-40	+125	°C

Electrical Characteristics (@T_A = +25°C, V_{IN} = V_{OUT} + 1.0V, C_{IN} = C_{OUT} = 1.0μF, I_{OUT} = 1.0mA, unless otherwise specified.)

Parameter	Condition	Min	Typ	Max	Unit	
Input Voltage	T _A = -40°C to +85°C	1.7	—	5.25	V	
Output Voltage Accuracy (Note 5)	V _{OUT(T)} ≥ 2.0V, V _{IN} = V _{OUT(T)} + 1V, T _A = +25°C	V _{OUT(T)} × 0.99	V _{OUT(T)}	V _{OUT(T)} × 1.01	V	
	V _{OUT(T)} < 2.0V, V _{IN} = V _{OUT(T)} + 1V, T _A = +25°C	V _{OUT(T)} - 20mV	V _{OUT(T)}	V _{OUT(T)} + 20mV		
Line Regulation (dV _{OUT} /dV _{IN} /V _{OUT})	V _{IN} = (V _{OUT - Nom} + 1.0V) to 5.25V, I _{OUT} = 1.0mA	—	0.02	0.1	%/V	
Load Regulation	V _{IN} = V _{OUT - Nom} + 1.0V, I _{OUT} = 1mA to 300mA	—	15	30	mV	
Quiescent Current (Note 6)	I _{OUT} = 0mA	—	35	60	μA	
I _{STANDBY}	V _{EN} = 0V (Disabled)	—	0.01	1.0	μA	
Output Current	—	300	—	—	mA	
Foldback Short Current (Note 7)	V _{OUT} Short to Ground	—	55	—	mA	
PSRR (Note 8)	V _{IN} = (V _{OUT} + 1V) V _{DC} + 0.2Vp-pAC V _{OUT} ≥ 1.8V, I _{OUT} = 30mA, f = 1kHz	—	75	—	dB	
Output Noise Voltage (Notes 8 & 9)	BW = 10Hz to 100kHz, I _{OUT} = 30mA	—	60	—	μVrms	
Dropout Voltage (Note 10)	I _{OUT} = 300mA (SOT25)	V _{OUT} = 0.9V	—	0.51	0.82	V
		1.0V < V _{OUT} ≤ 1.2V	—	0.46	0.72	
		1.2V < V _{OUT} ≤ 1.4V	—	0.39	0.60	
		1.4V < V _{OUT} ≤ 1.7V	—	0.35	0.46	
		1.7V < V _{OUT} ≤ 2.1V	—	0.30	0.41	
		2.1V < V _{OUT} ≤ 2.5V	—	0.26	0.36	
		2.5V < V _{OUT} ≤ 3.0V	—	0.25	0.32	
3.0V < V _{OUT} ≤ 3.6V	—	0.22	0.31			
Output Voltage Temperature Coefficient	I _{OUT} = 30mA, T _A = -40°C to +125°C	—	±30	—	ppm/°C	
Thermal Shutdown Threshold (TSHDN)	—	—	+150	—	°C	
Thermal Shutdown Hysteresis (THYS)	—	—	+20	—	°C	
EN Input Low Voltage	—	0	—	0.5	V	
EN Input High Voltage	—	1.3	—	5.25	V	
EN Input Leakage	V _{EN} = 0V, V _{IN} = 5.0V or V _{EN} = 5.0V, V _{IN} = 0V	-1.0	—	+1.0	μA	
On Resistance of N-Channel for Auto-Discharge (Note 11)	V _{IN} = 4.0V, V _{EN} = 0V (Disabled)	—	30	—	Ω	
Thermal Resistance Junction to Ambient (θ _{JA})	SOT25	—	179	—	°C/W	
	W-DFN2020-6 (SWP) (Type A1) (Wettable)	—	54	—		
	W-DFN2020-6 (SWP) (Type UXD) (Wettable)	—	53.3	—		
Thermal Resistance Junction to Case (θ _{JC})	SOT25	—	52	—	°C/W	
	W-DFN2020-6 (SWP) (Type A1) (Wettable)	—	17	—		
	W-DFN2020-6 (SWP) (Type UXD) (Wettable)	—	18.3	—		

- Notes:
5. Potential multiple grades based on following output voltage accuracy.
 6. Quiescent current defined here is the difference in current between the input and the output.
 7. Short-circuit current is measured with V_{OUT} pulled to GND.
 8. This specification is guaranteed by design.
 9. To make sure lowest environment noise minimizes the influence on noise measurement.
 10. Dropout voltage is the voltage difference between the input and the output at which the output voltage drops 2% below its nominal value.
 11. AP7343Q has two options for output, built-in discharge and non-discharge.

Typical Characteristics

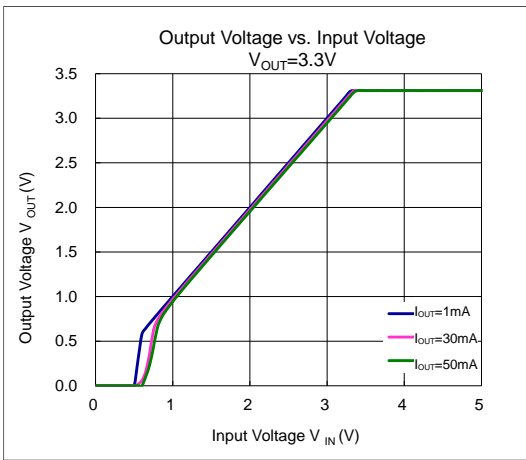
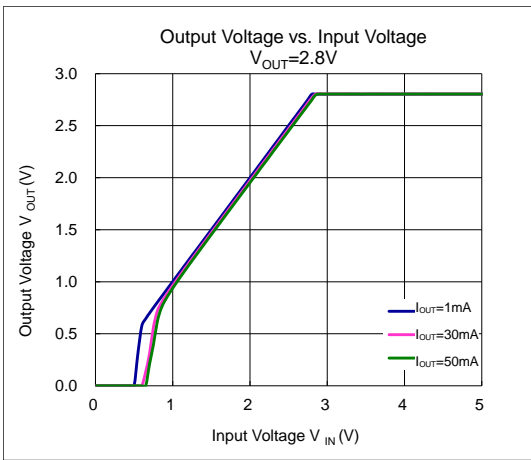
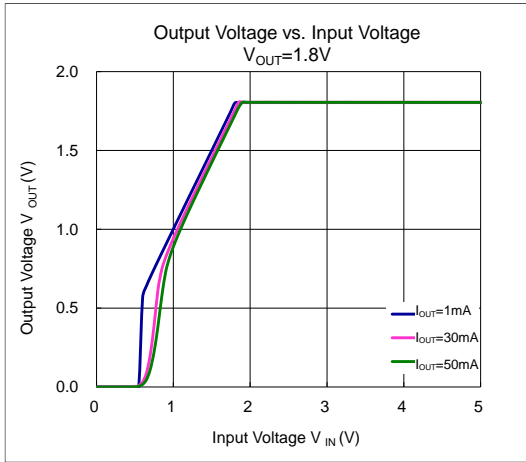
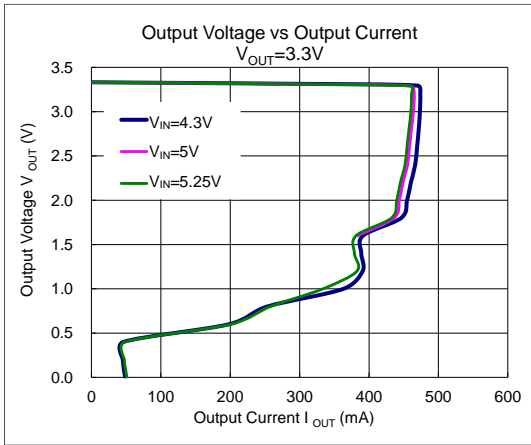
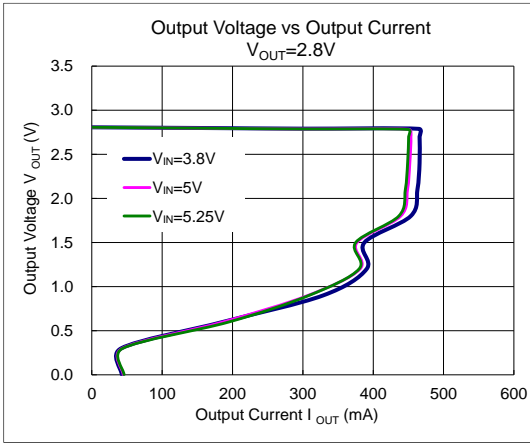
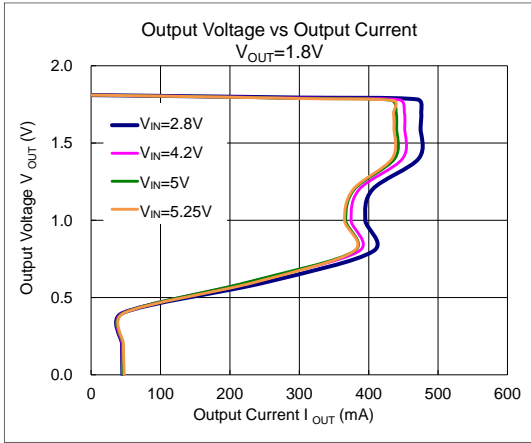

Typical Characteristics (continued)

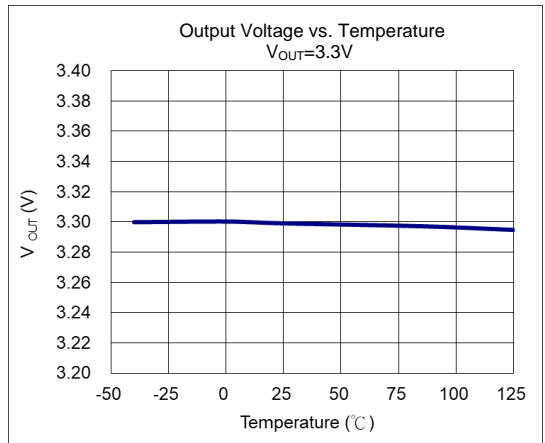
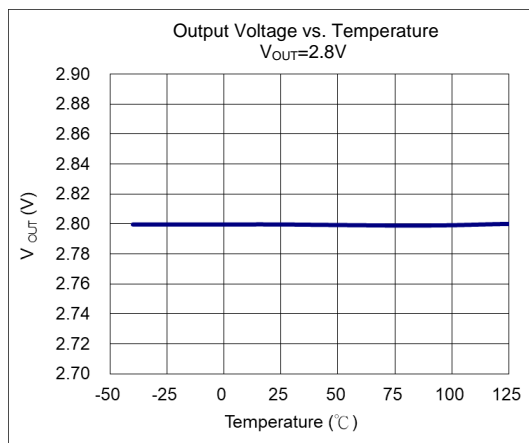
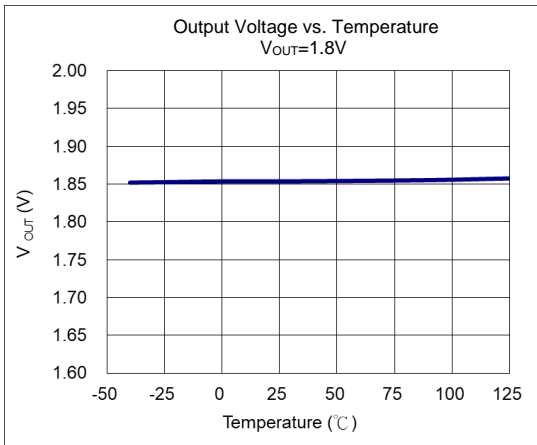
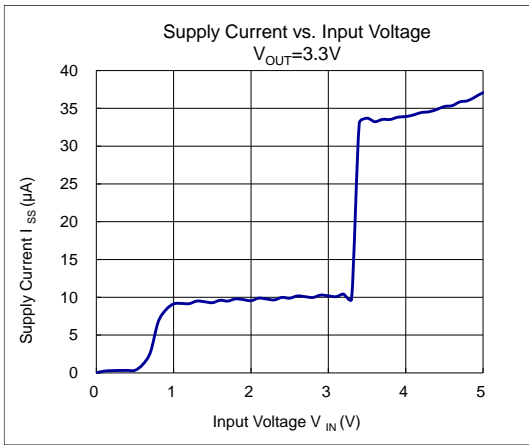
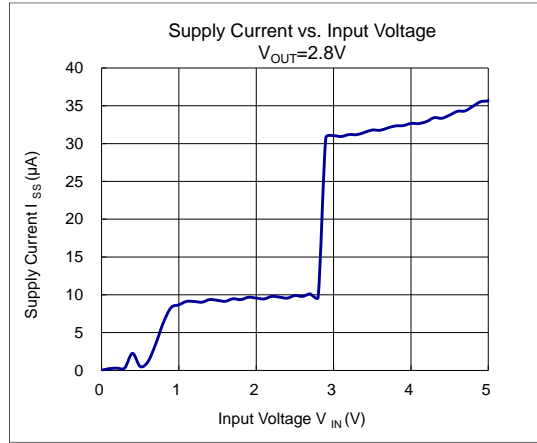
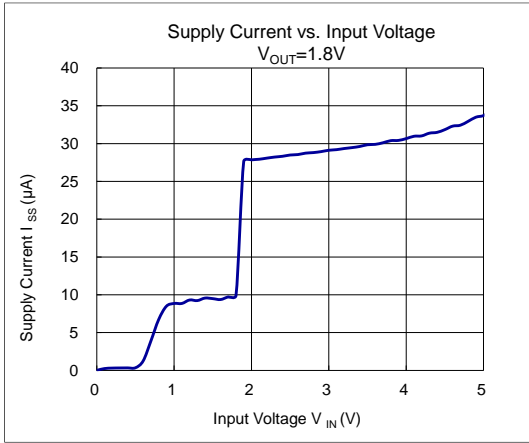

Typical Characteristics (continued)

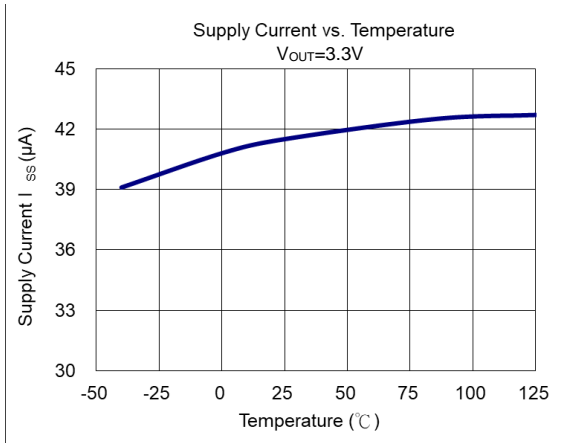
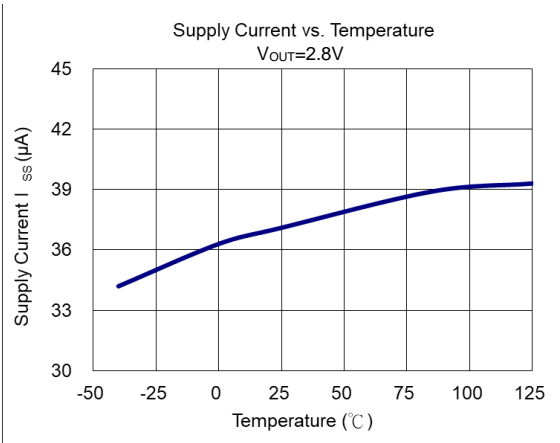
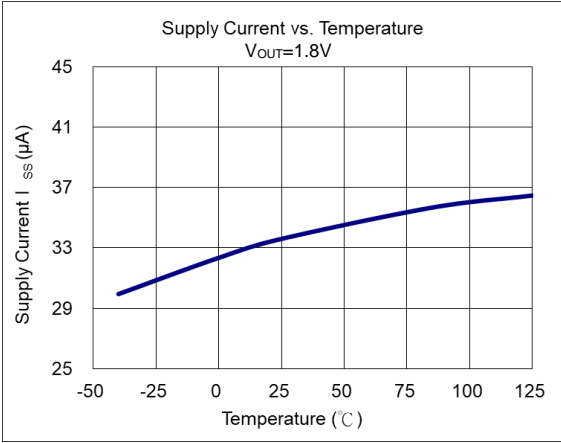
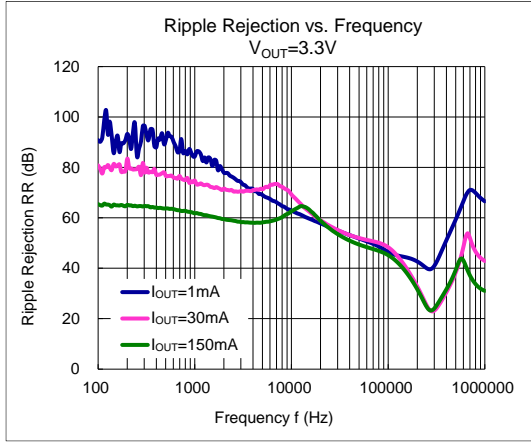
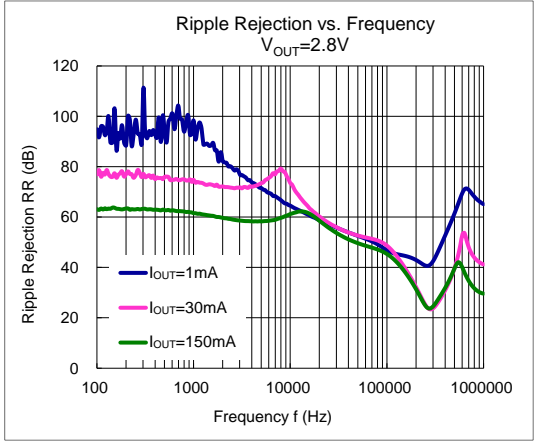
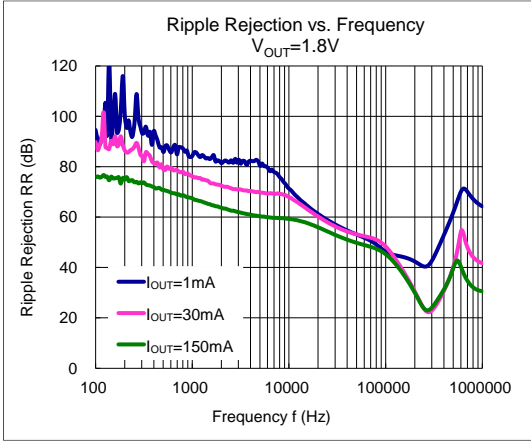

Typical Characteristics (continued)

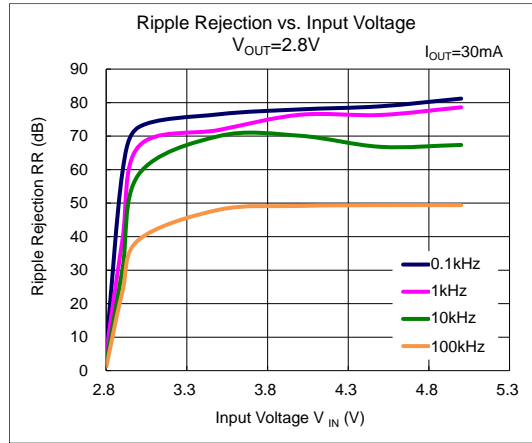
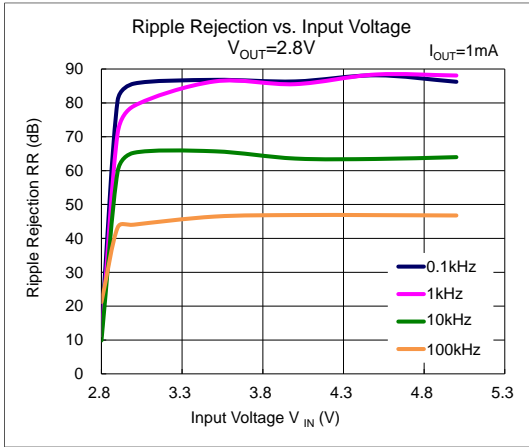

Line Transient Response Waveforms ($I_{OUT} = 30mA$, $t_R = t_F = 5\mu s$, $C_{IN} = \text{None}$, $C_{OUT1} = C_{OUT2} = 1\mu F$, $T_A = +25^\circ C$)

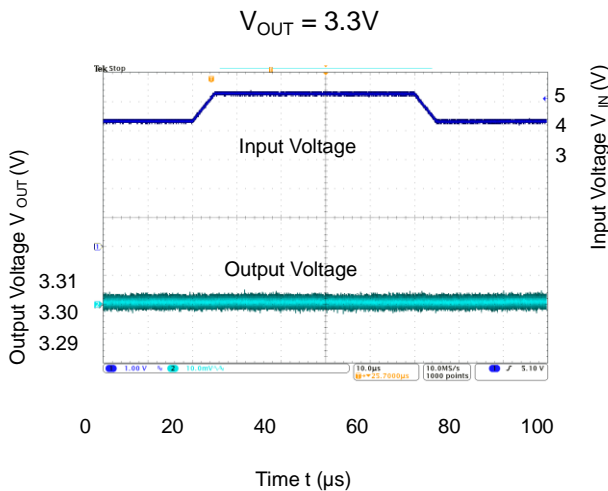
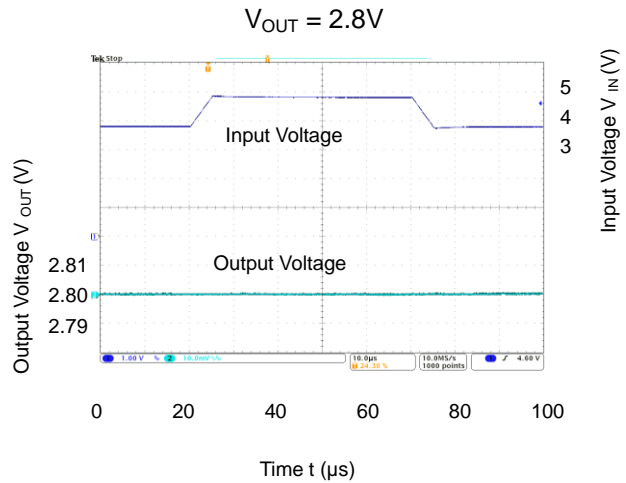
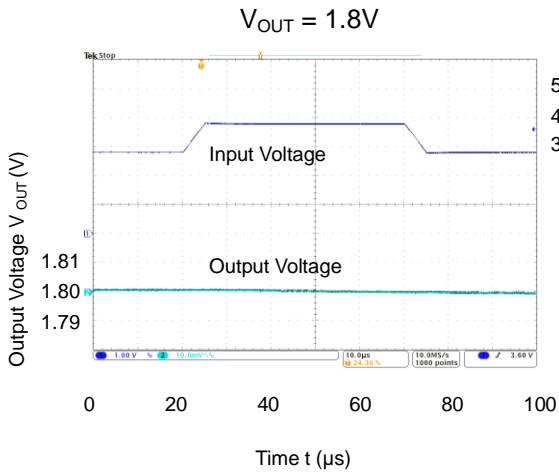

Typical Characteristics (continued)

Load Transient Response Waveforms ($V_{IN} = V_{OUT} + 1V$, $C_{IN} = 1\mu F$, $T_A = +25^\circ C$)

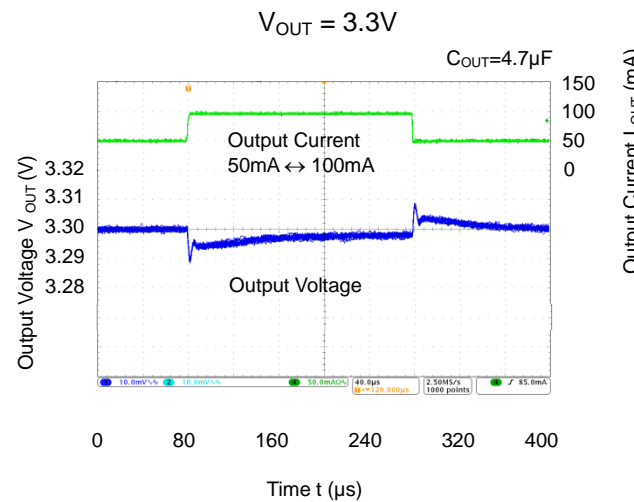
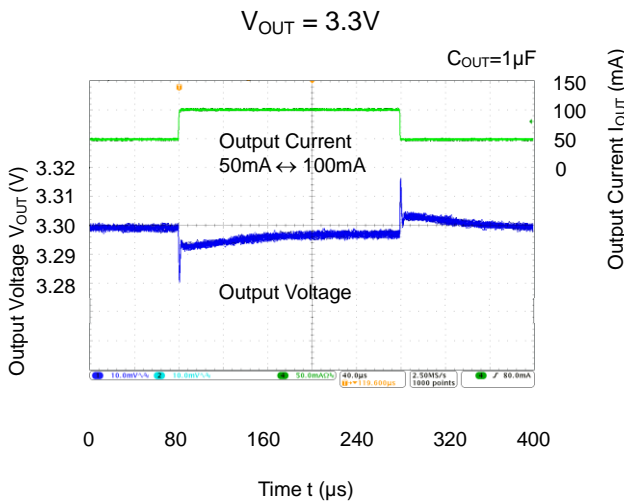
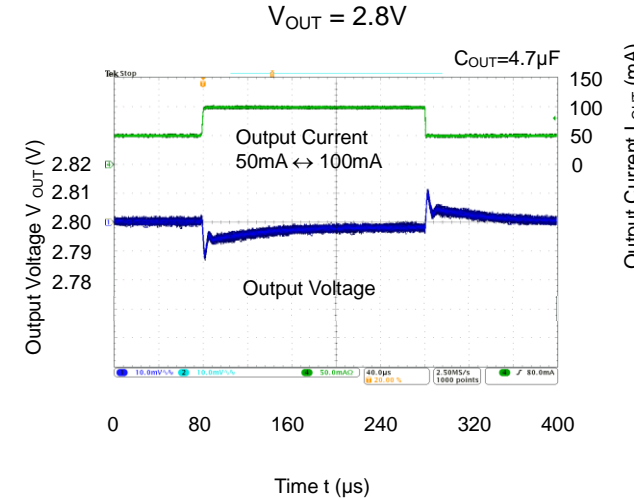
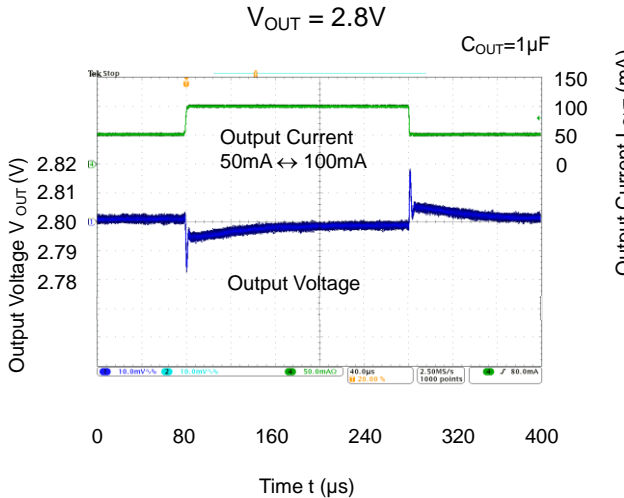
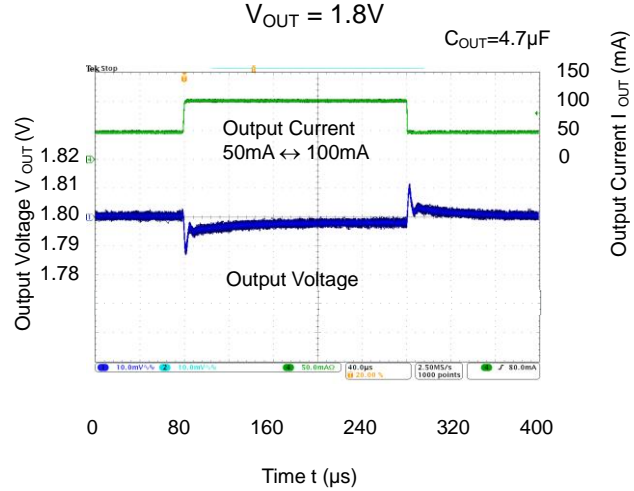
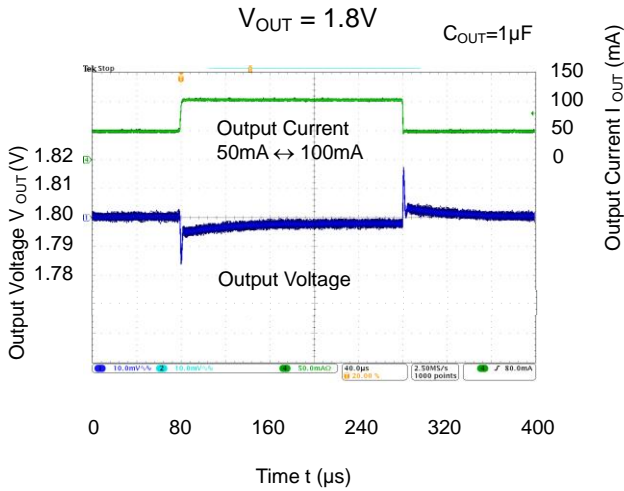

Typical Characteristics (continued)

Load Transient Response Waveforms ($V_{IN} = V_{OUT} + 1V$, $C_{IN} = 1\mu F$, $T_A = +25^\circ C$)

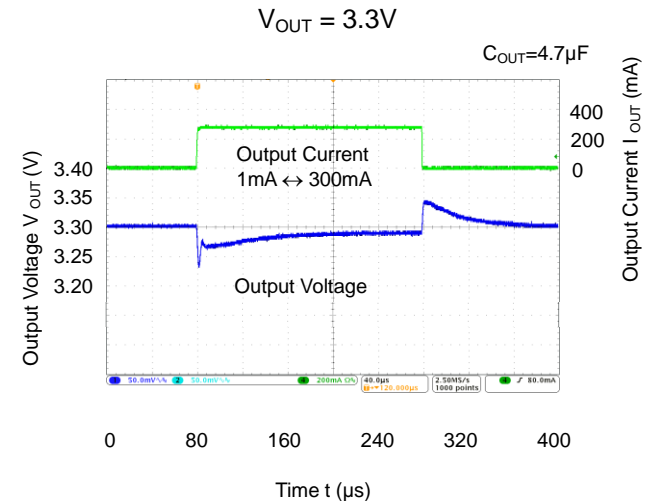
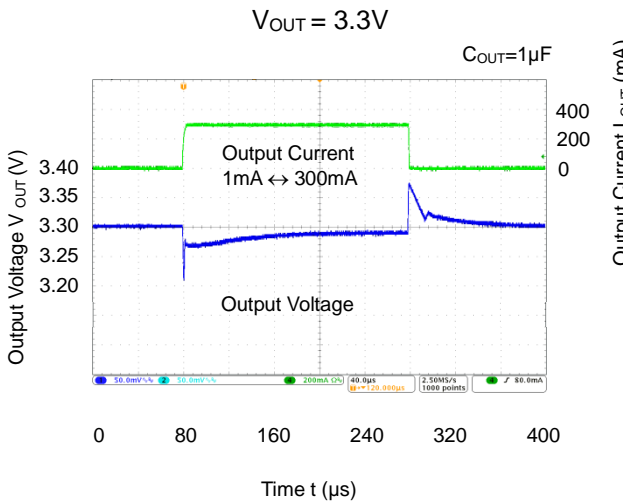
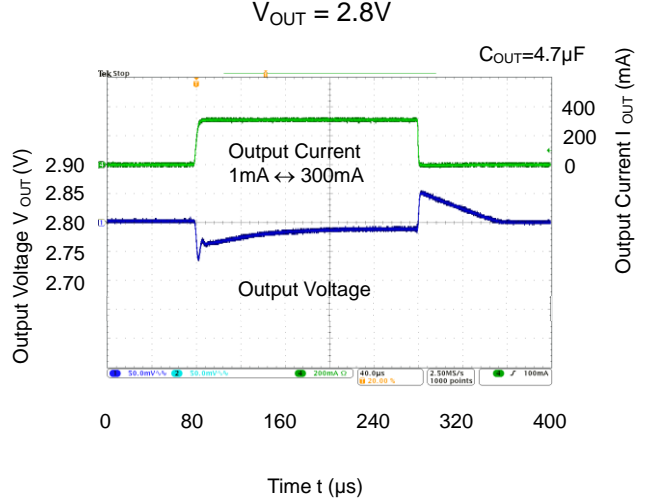
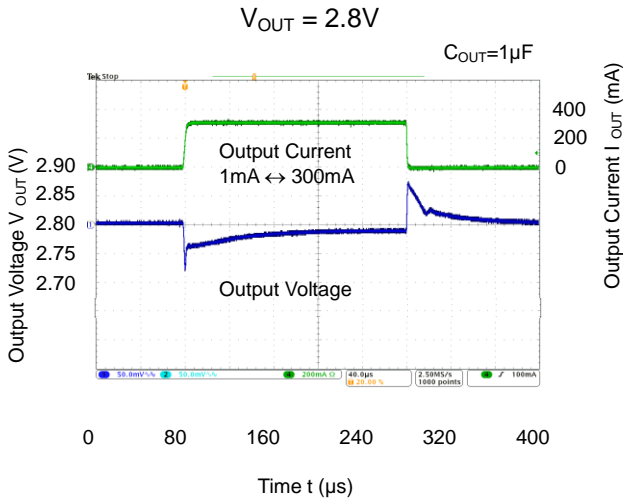
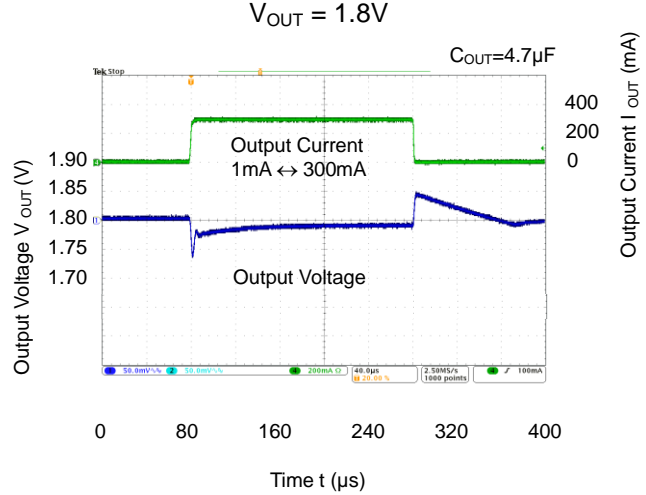
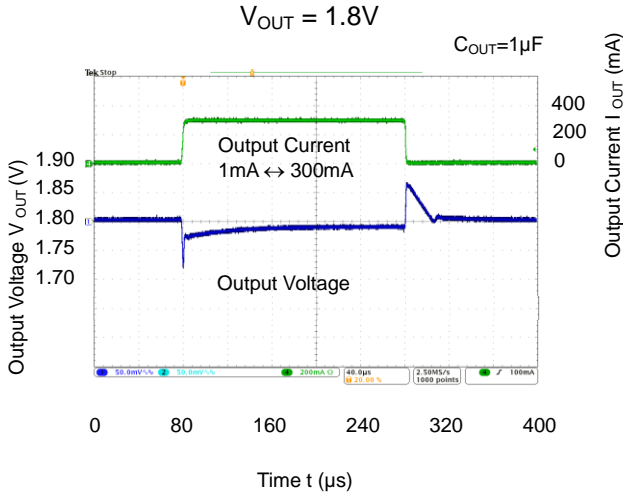

Typical Characteristics (continued)

Turn On & Off Waveforms ($V_{IN} = V_{OUT} + 1V$, $C_{IN} = 1\mu F$, $C_{OUT} = 1\mu F$, $T_A = +25^\circ C$)

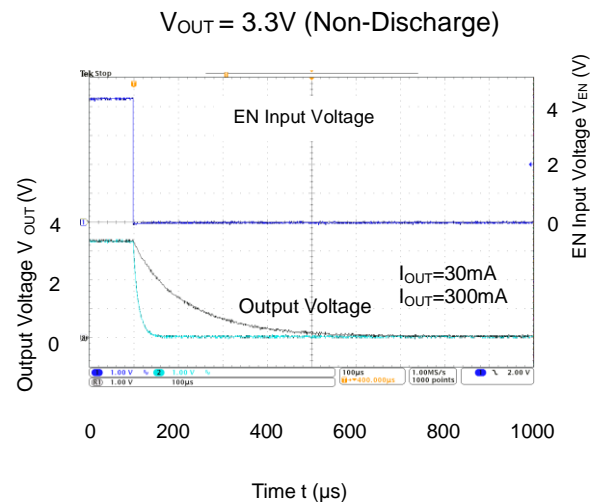
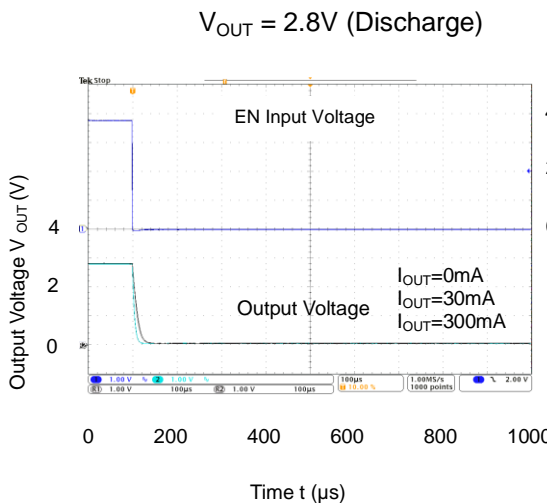
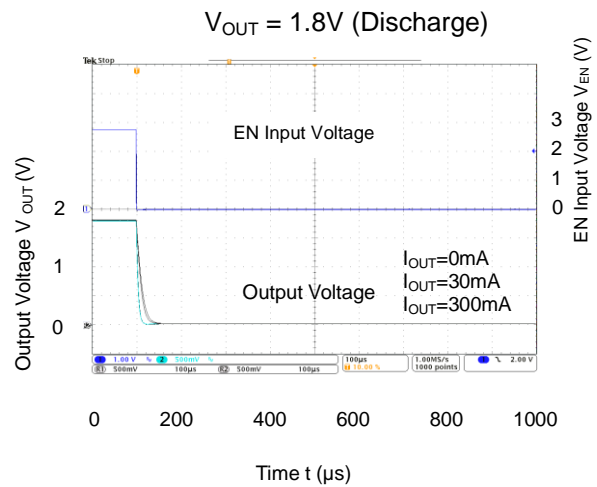
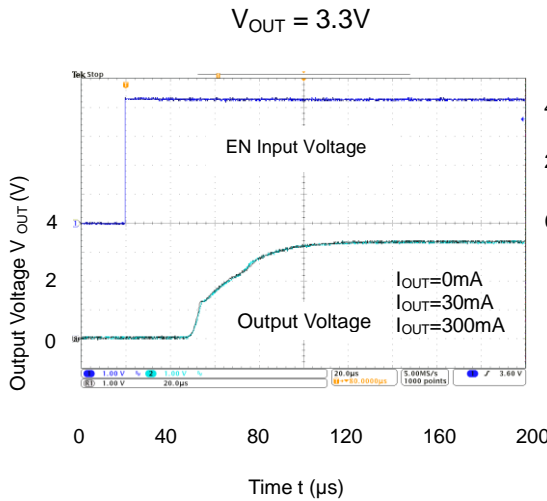
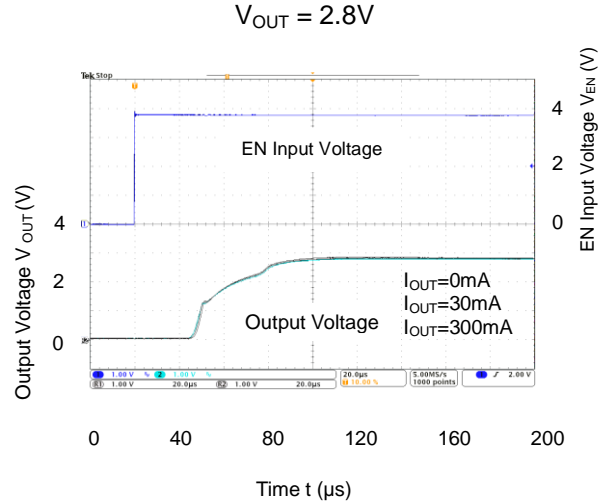
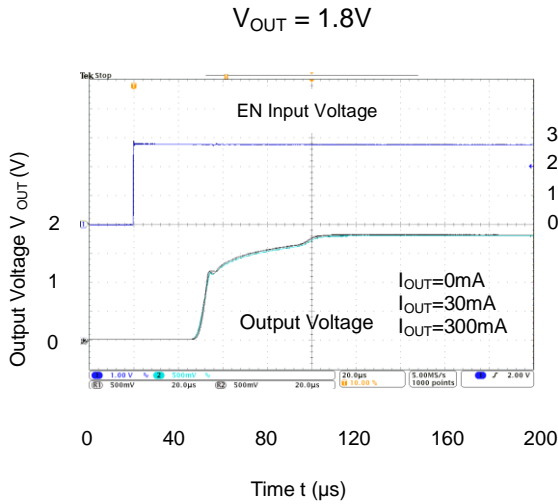

Application Information

Output Capacitor

An output capacitor (C_{OUT}) is required to improve transient response and maintain stability. The AP7343Q is stable with very-small ceramic-output capacitors. The ESR (equivalent series resistance) and capacitance drive the selection. If the application has large load variations, it is recommended to utilize low-ESR bulk capacitors. It is recommended to place ceramic capacitors as close as possible to the load, and the ground pin and care should be taken to reduce the impedance in the layout.

Input Capacitor

To prevent the input voltage from dropping during load steps, it is recommended to utilize an input capacitor (C_{IN}). A minimum $0.47\mu\text{F}$ ceramic capacitor is recommended between V_{IN} and GND pins to decouple input power supply glitch. This input capacitor must be located as close as possible to the device to ensure input stability and reduce noise. For PCB layout, a wide copper trace is required for both V_{IN} and GND pins.

Enable Control

The AP7343Q is turned on by setting the EN pin high and is turned off by pulling it low. If this feature is not used, the EN pin should be tied to V_{IN} pin to keep the regulator output on at all times. To ensure proper operation, the signal source used to drive the EN pin must be able to swing above and below the specified turn-on/off voltage thresholds listed in the *Electrical Characteristics* section.

Short-Circuit Protection

When V_{OUT} pin is short-circuited to GND, short-circuit protection is triggered and clamps the output current to approximately 60mA. This feature protects the regulator from overcurrent and damage due to overheating.

Layout Considerations

For good ground loop and stability, the input and output capacitors should be located close to the input, output, and ground pins of the device. The regulator ground pin should be connected to the external circuit ground to reduce voltage drop caused by trace impedance. Ground plane is generally used to reduce trace impedance. Wide trace should be used for large current paths from V_{IN} to V_{OUT} and load circuit.

ESR vs. Output Current

Ceramic type output capacitor is recommended for this series; however, the other output capacitors with low ESR also can be used. The relations between I_{OUT} (output current) and ESR of an output capacitor are shown below. The stable region is marked as the hatched area in the graph.

Measurement conditions: Frequency Band: 10Hz to 2MHz, Temperature: -40°C to $+125^{\circ}\text{C}$.

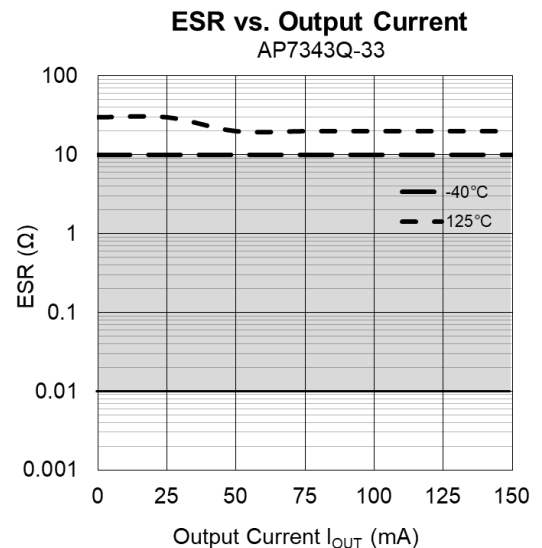
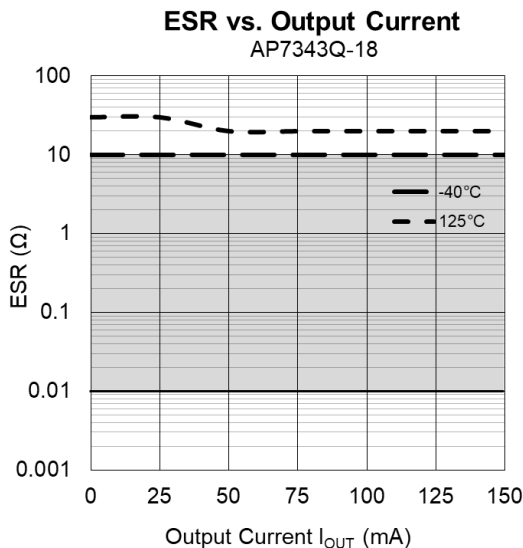

Ordering Information (Notes 12, 13 & 14)

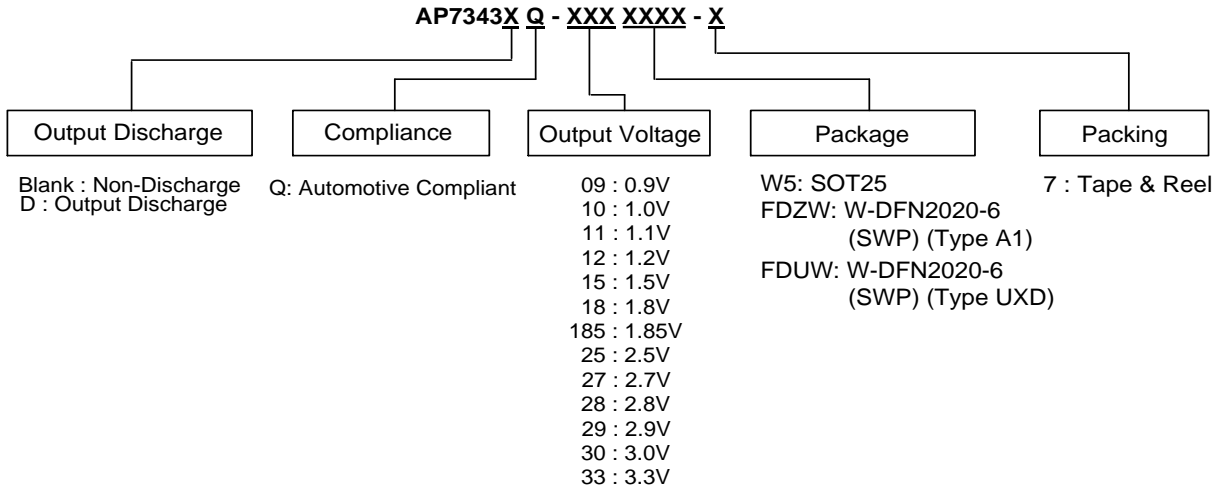

Orderable Part Number	Part Number Suffix	Package Code	Package	Packing	
				Qty.	Carrier
AP7343Q-XXXW5-7	-7	W5	SOT25	3000	7" Tape & Reel
AP7343DQ-XXXW5-7	-7	W5	SOT25	3000	7" Tape & Reel
AP7343Q-XXXFDZW-7	-7	FDZW	W-DFN2020-6 (SWP) (Type A1)	3000	7" Tape & Reel
AP7343DQ-XXXFDZW-7	-7	FDZW	W-DFN2020-6 (SWP) (Type A1)	3000	7" Tape & Reel
AP7343Q-XXXFDUW-7	-7	FDUW	W-DFN2020-6 (SWP) (Type UXD)	3000	7" Tape & Reel
AP7343DQ-XXXFDUW-7	-7	FDUW	W-DFN2020-6 (SWP) (Type UXD)	3000	7" Tape & Reel

- Notes:
- 12. For packaging details, go to our website at <https://www.diodes.com/design/support/packaging/diodes-packaging/>.
 - 13. Other output voltage variants may be available in 100mV steps. For more information, please contact your local Diodes Incorporated sales representative.
 - 14. AP7343Q and AP7343DQ are qualified to AEC-Q100 grade 1 and are classified as "Automotive Compliant" supporting PPAP documentation. Automotive compliant and standard products are electrically and thermally the same, except where specified. For more information, please refer to <https://www.diodes.com/quality/product-definitions/>.

Marking Information

(1) SOT25

(Top View)

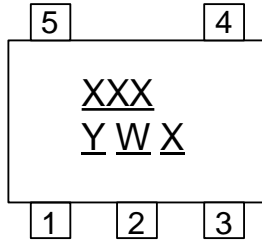

XXX : Identification Code
Y : Year 0 to 9 (ex: 4 = 2024)
W : Week : A to Z : Week 1 to 26;
a to z : Week 27 to 52; z represents
Week 52 and 53
X : Internal Code

Orderable Part Number	Package	Identification Code
AP7343Q-09W5-7	SOT25	7BQ
AP7343Q-10W5-7	SOT25	7CQ
AP7343Q-11W5-7	SOT25	7EQ
AP7343Q-12W5-7	SOT25	7FQ
AP7343Q-15W5-7	SOT25	7HQ
AP7343Q-18W5-7	SOT25	7JQ
AP7343Q-185W5-7	SOT25	7KQ
AP7343Q-25W5-7	SOT25	7NQ
AP7343Q-27W5-7	SOT25	7XQ
AP7343Q-28W5-7	SOT25	7PQ
AP7343Q-29W5-7	SOT25	8AQ
AP7343Q-30W5-7	SOT25	7TQ
AP7343Q-33W5-7	SOT25	7WQ
AP7343DQ-09W5-7	SOT25	8BQ
AP7343DQ-10W5-7	SOT25	8CQ
AP7343DQ-11W5-7	SOT25	8EQ
AP7343DQ-12W5-7	SOT25	8FQ
AP7343DQ-15W5-7	SOT25	8KQ
AP7343DQ-18W5-7	SOT25	8PQ
AP7343DQ-25W5-7	SOT25	8XQ
AP7343DQ-27W5-7	SOT25	8ZQ
AP7343DQ-28W5-7	SOT25	6JQ
AP7343DQ-29W5-7	SOT25	6MQ
AP7343DQ-30W5-7	SOT25	6PQ
AP7343DQ-33W5-7	SOT25	6TQ

Marking Information (continued)

(2) W-DFN2020-6 (SWP) (Type A1)

(Top View)

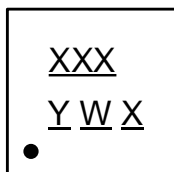

XXX : Identification Code
Y : Year : 0 to 9 (ex: 4 = 2024)
W : Week : A to Z : week 1 to 26;
a to z : week 27 to 52; z represents week 52 and 53
X : Internal Code

Orderable Part Number	Package	Identification Code
AP7343Q-09FDZW-7	W-DFN2020-6 (SWP) (Type A1)	7BQ
AP7343Q-10FDZW-7	W-DFN2020-6 (SWP) (Type A1)	7CQ
AP7343Q-11FDZW-7	W-DFN2020-6 (SWP) (Type A1)	7EQ
AP7343Q-12FDZW-7	W-DFN2020-6 (SWP) (Type A1)	7FQ
AP7343Q-15FDZW-7	W-DFN2020-6 (SWP) (Type A1)	7HQ
AP7343Q-18FDZW-7	W-DFN2020-6 (SWP) (Type A1)	7JQ
AP7343Q-185FDZW-7	W-DFN2020-6 (SWP) (Type A1)	7KQ
AP7343Q-25FDZW-7	W-DFN2020-6 (SWP) (Type A1)	7NQ
AP7343Q-27FDZW-7	W-DFN2020-6 (SWP) (Type A1)	7XQ
AP7343Q-28FDZW-7	W-DFN2020-6 (SWP) (Type A1)	7PQ
AP7343Q-29FDZW-7	W-DFN2020-6 (SWP) (Type A1)	8AQ
AP7343Q-30FDZW-7	W-DFN2020-6 (SWP) (Type A1)	7TQ
AP7343Q-33FDZW-7	W-DFN2020-6 (SWP) (Type A1)	7WQ
AP7343DQ-09FDZW-7	W-DFN2020-6 (SWP) (Type A1)	8BQ
AP7343DQ-10FDZW-7	W-DFN2020-6 (SWP) (Type A1)	8CQ
AP7343DQ-11FDZW-7	W-DFN2020-6 (SWP) (Type A1)	8EQ
AP7343DQ-12FDZW-7	W-DFN2020-6 (SWP) (Type A1)	8FQ
AP7343DQ-15FDZW-7	W-DFN2020-6 (SWP) (Type A1)	8KQ
AP7343DQ-18FDZW-7	W-DFN2020-6 (SWP) (Type A1)	8PQ
AP7343DQ-25FDZW-7	W-DFN2020-6 (SWP) (Type A1)	8XQ
AP7343DQ-27FDZW-7	W-DFN2020-6 (SWP) (Type A1)	8ZQ
AP7343DQ-28FDZW-7	W-DFN2020-6 (SWP) (Type A1)	6JQ
AP7343DQ-29FDZW-7	W-DFN2020-6 (SWP) (Type A1)	6MQ
AP7343DQ-30FDZW-7	W-DFN2020-6 (SWP) (Type A1)	6PQ
AP7343DQ-33FDZW-7	W-DFN2020-6 (SWP) (Type A1)	6TQ

Marking Information (continued)

(3) W-DFN2020-6 (SWP) (Type UXD)

(Top View)

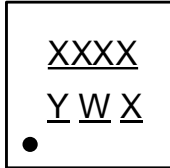

XXXX : Identification Code

Y : Year : 0 to 9 (ex: 4 = 2024)

W : Week : A to Z : week 1 to 26;
a to z : week 27 to 52; z represents week 52 and 53

X : Internal Code

Orderable Part Number	Package	Identification Code
AP7343Q-09FDUW-7	W-DFN2020-6 (SWP) (Type UXD)	E7AQ
AP7343Q-10FDUW-7	W-DFN2020-6 (SWP) (Type UXD)	E7BQ
AP7343Q-11FDUW-7	W-DFN2020-6 (SWP) (Type UXD)	E7CQ
AP7343Q-12FDUW-7	W-DFN2020-6 (SWP) (Type UXD)	E7DQ
AP7343Q-15FDUW-7	W-DFN2020-6 (SWP) (Type UXD)	E7EQ
AP7343Q-18FDUW-7	W-DFN2020-6 (SWP) (Type UXD)	E7FQ
AP7343Q-185FDUW-7	W-DFN2020-6 (SWP) (Type UXD)	E7GQ
AP7343Q-25FDUW-7	W-DFN2020-6 (SWP) (Type UXD)	E7HQ
AP7343Q-27FDUW-7	W-DFN2020-6 (SWP) (Type UXD)	E7JQ
AP7343Q-28FDUW-7	W-DFN2020-6 (SWP) (Type UXD)	E7KQ
AP7343Q-29FDUW-7	W-DFN2020-6 (SWP) (Type UXD)	E7MQ
AP7343Q-30FDUW-7	W-DFN2020-6 (SWP) (Type UXD)	E7NQ
AP7343Q-33FDUW-7	W-DFN2020-6 (SWP) (Type UXD)	E7PQ
AP7343DQ-09FDUW-7	W-DFN2020-6 (SWP) (Type UXD)	E7RQ
AP7343DQ-10FDUW-7	W-DFN2020-6 (SWP) (Type UXD)	E7SQ
AP7343DQ-11FDUW-7	W-DFN2020-6 (SWP) (Type UXD)	E7TQ
AP7343DQ-12FDUW-7	W-DFN2020-6 (SWP) (Type UXD)	E7UQ
AP7343DQ-15FDUW-7	W-DFN2020-6 (SWP) (Type UXD)	E7VQ
AP7343DQ-18FDUW-7	W-DFN2020-6 (SWP) (Type UXD)	E7WQ
AP7343DQ-25FDUW-7	W-DFN2020-6 (SWP) (Type UXD)	E7XQ
AP7343DQ-27FDUW-7	W-DFN2020-6 (SWP) (Type UXD)	E7YQ
AP7343DQ-28FDUW-7	W-DFN2020-6 (SWP) (Type UXD)	E7ZQ
AP7343DQ-29FDUW-7	W-DFN2020-6 (SWP) (Type UXD)	E72Q
AP7343DQ-30FDUW-7	W-DFN2020-6 (SWP) (Type UXD)	E73Q
AP7343DQ-33FDUW-7	W-DFN2020-6 (SWP) (Type UXD)	E74Q

Package Outline Dimensions

Please see <http://www.diodes.com/package-outlines.html> for the latest version.

(1) SOT25

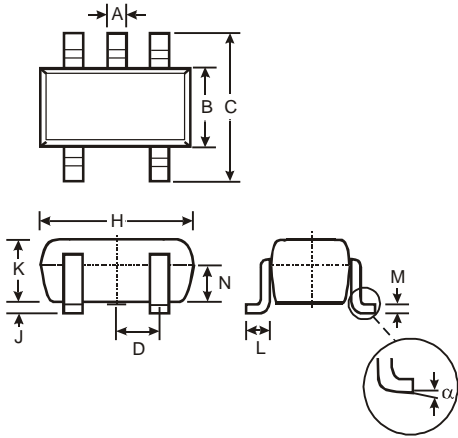

SOT25			
Dim	Min	Max	Typ
A	0.35	0.50	0.38
B	1.50	1.70	1.60
C	2.70	3.00	2.80
D	-	-	0.95
H	2.90	3.10	3.00
J	0.013	0.10	0.05
K	1.00	1.30	1.10
L	0.35	0.55	0.40
M	0.10	0.20	0.15
N	0.70	0.80	0.75
α	0°	8°	-
All Dimensions in mm			

(2) W-DFN2020-6 (SWP) (Type A1)

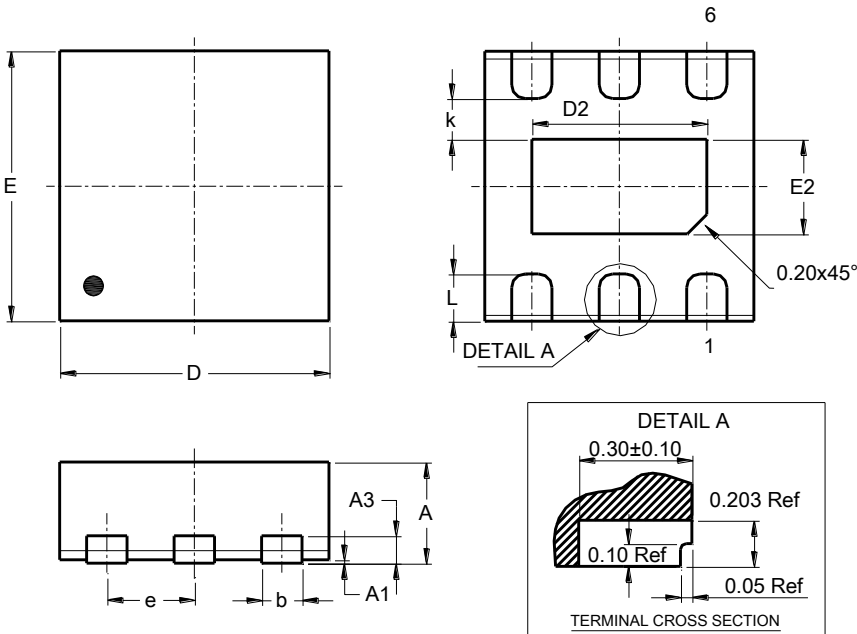

W-DFN2020-6 (SWP) (Type A1)			
Dim	Min	Max	Typ
A	0.70	0.80	0.75
A1	0.00	0.05	0.02
A3	0.203 REF		
b	0.25	0.35	0.30
D	2.00 BSC		
D2	1.35	1.45	1.40
E	2.00 BSC		
E2	0.55	0.65	0.60
e	0.65 BSC		
k	0.20	—	—
L	0.20	0.40	0.30
All Dimensions in mm			

Package Outline Dimensions (continued)

Please see <http://www.diodes.com/package-outlines.html> for the latest version.

(3) W-DFN2020-6 (SWP) (Type UXD)

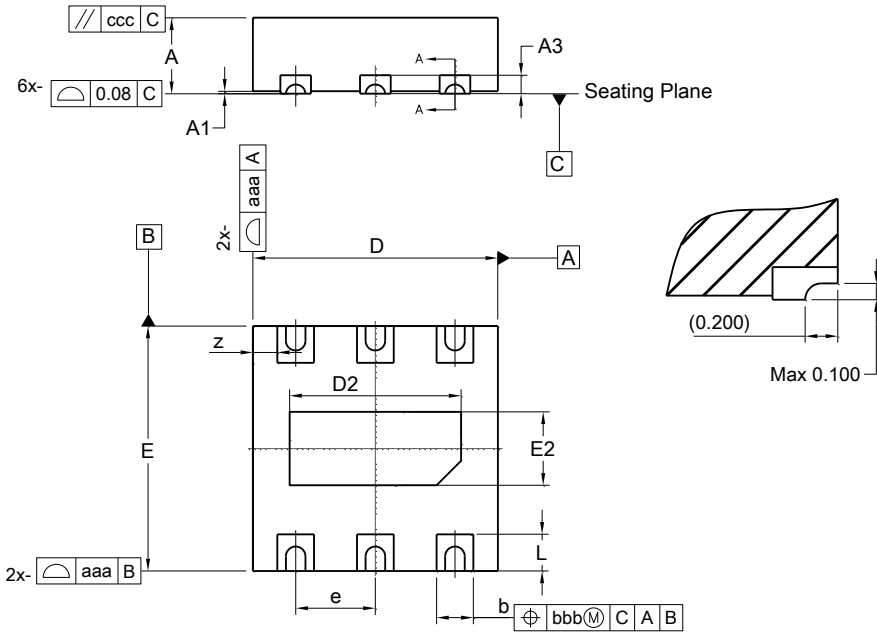

W-DFN2020-6 (SWP) (Type UXD)			
Dim	Min	Max	Typ
A	0.70	0.80	0.75
A1	0.00	0.05	0.02
A3	—	—	0.15
b	0.25	0.35	0.30
D	1.95	2.075	2.00
D2	1.35	1.45	1.40
E	1.95	2.075	2.00
E2	0.55	0.65	0.60
e	—	—	0.65
L	0.20	0.40	0.30
z	—	—	0.20
aaa	0.25		
bbb	0.10		
ccc	0.10		
All Dimensions in mm			

Suggested Pad Layout

Please see <http://www.diodes.com/package-outlines.html> for the latest version.

(1) SOT25

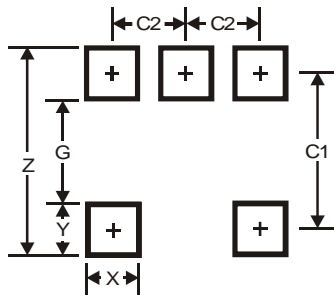

Dimensions	Value (in mm)
Z	3.20
G	1.60
X	0.55
Y	0.80
C1	2.40
C2	0.95

Suggested Pad Layout (continued)

Please see <http://www.diodes.com/package-outlines.html> for the latest version.

(2) **W-DFN2020-6 (SWP) (Type A1)**

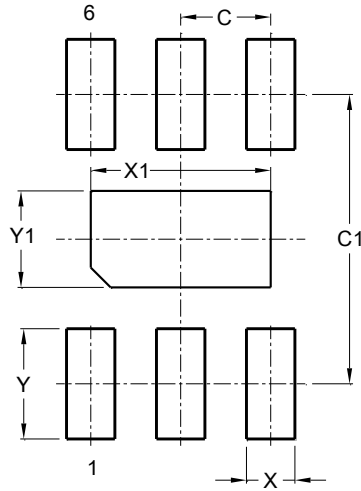

Dimensions	Value (in mm)
C	0.650
C1	2.100
X	0.350
X1	1.400
Y	0.800
Y1	0.600

(3) **W-DFN2020-6 (SWP) (Type UXD)**

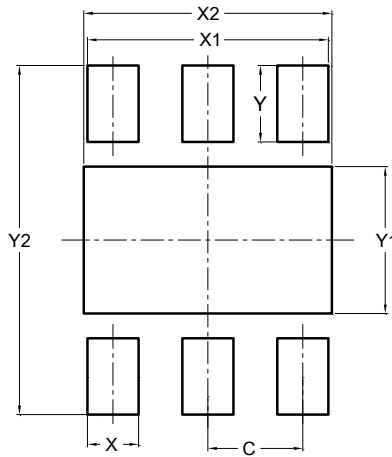

Dimensions	Value (in mm)
C	0.650
X	0.350
X1	1.650
X2	1.700
Y	0.525
Y1	1.010
Y2	2.400

Mechanical Data

- Moisture Sensitivity: Level 1 Per J-STD-020
- Terminals: Finish – Matte Tin Plated Leads, Solderable per MIL-STD-202, Method 208 ③
- Weight:
 - SOT25: 0.016 grams (Approximate)
 - W-DFN2020-6 (SWP) (Type A1): 0.010 grams (Approximate)
 - W-DFN2020-6 (SWP) (Type UXD): 0.010 grams (Approximate)

Tape Orientation

For AP7343Q-XXXW5-7 & AP7343DQ-XXXW5-7

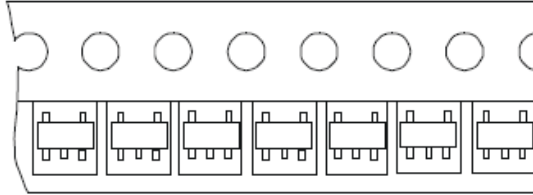

For AP7343DQ-XXXFDZW-7

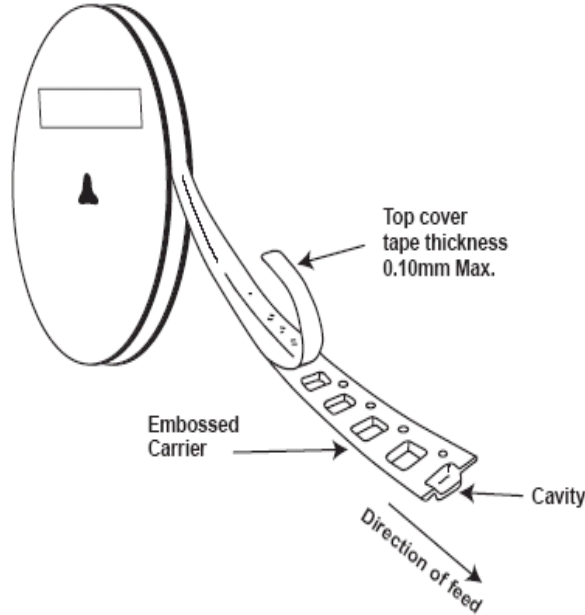
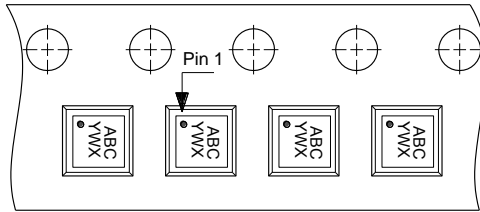

Note: 15. The taping orientation of the other package type can be found on our website at <https://www.diodes.com/assets/Packaging-Support-Docs/ap02007.pdf>.

IMPORTANT NOTICE

1. DIODES INCORPORATED (Diodes) AND ITS SUBSIDIARIES MAKE NO WARRANTY OF ANY KIND, EXPRESS OR IMPLIED, WITH REGARDS TO ANY INFORMATION CONTAINED IN THIS DOCUMENT, INCLUDING, BUT NOT LIMITED TO, THE IMPLIED WARRANTIES OF MERCHANTABILITY, FITNESS FOR A PARTICULAR PURPOSE OR NON-INFRINGEMENT OF THIRD PARTY INTELLECTUAL PROPERTY RIGHTS (AND THEIR EQUIVALENTS UNDER THE LAWS OF ANY JURISDICTION).
2. The Information contained herein is for informational purpose only and is provided only to illustrate the operation of Diodes' products described herein and application examples. Diodes does not assume any liability arising out of the application or use of this document or any product described herein. This document is intended for skilled and technically trained engineering customers and users who design with Diodes' products. Diodes' products may be used to facilitate safety-related applications; however, in all instances customers and users are responsible for (a) selecting the appropriate Diodes products for their applications, (b) evaluating the suitability of Diodes' products for their intended applications, (c) ensuring their applications, which incorporate Diodes' products, comply the applicable legal and regulatory requirements as well as safety and functional-safety related standards, and (d) ensuring they design with appropriate safeguards (including testing, validation, quality control techniques, redundancy, malfunction prevention, and appropriate treatment for aging degradation) to minimize the risks associated with their applications.
3. Diodes assumes no liability for any application-related information, support, assistance or feedback that may be provided by Diodes from time to time. Any customer or user of this document or products described herein will assume all risks and liabilities associated with such use, and will hold Diodes and all companies whose products are represented herein or on Diodes' websites, harmless against all damages and liabilities.
4. Products described herein may be covered by one or more United States, international or foreign patents and pending patent applications. Product names and markings noted herein may also be covered by one or more United States, international or foreign trademarks and trademark applications. Diodes does not convey any license under any of its intellectual property rights or the rights of any third parties (including third parties whose products and services may be described in this document or on Diodes' website) under this document.
5. Diodes' products are provided subject to Diodes' Standard Terms and Conditions of Sale (<https://www.diodes.com/about/company/terms-and-conditions/terms-and-conditions-of-sales/>) or other applicable terms. This document does not alter or expand the applicable warranties provided by Diodes. Diodes does not warrant or accept any liability whatsoever in respect of any products purchased through unauthorized sales channel.
6. Diodes' products and technology may not be used for or incorporated into any products or systems whose manufacture, use or sale is prohibited under any applicable laws and regulations. Should customers or users use Diodes' products in contravention of any applicable laws or regulations, or for any unintended or unauthorized application, customers and users will (a) be solely responsible for any damages, losses or penalties arising in connection therewith or as a result thereof, and (b) indemnify and hold Diodes and its representatives and agents harmless against any and all claims, damages, expenses, and attorney fees arising out of, directly or indirectly, any claim relating to any noncompliance with the applicable laws and regulations, as well as any unintended or unauthorized application.
7. While efforts have been made to ensure the information contained in this document is accurate, complete and current, it may contain technical inaccuracies, omissions and typographical errors. Diodes does not warrant that information contained in this document is error-free and Diodes is under no obligation to update or otherwise correct this information. Notwithstanding the foregoing, Diodes reserves the right to make modifications, enhancements, improvements, corrections or other changes without further notice to this document and any product described herein. This document is written in English but may be translated into multiple languages for reference. Only the English version of this document is the final and determinative format released by Diodes.
8. Any unauthorized copying, modification, distribution, transmission, display or other use of this document (or any portion hereof) is prohibited. Diodes assumes no responsibility for any losses incurred by the customers or users or any third parties arising from any such unauthorized use.
9. This Notice may be periodically updated with the most recent version available at <https://www.diodes.com/about/company/terms-and-conditions/important-notice>

The Diodes logo is a registered trademark of Diodes Incorporated in the United States and other countries.
All other trademarks are the property of their respective owners.
© 2024 Diodes Incorporated. All Rights Reserved.

www.diodes.com