

RF Inductor



BWCS Series



Overview

Wire-wound RF inductors are electronic components designed to store energy in a magnetic field when electrical current passes through them. They are constructed by winding a conductive wire (usually copper or gold-plated) around a core material such as air, ceramic, or ferrite.

This configuration allows them to provide high inductance values with minimal power loss, especially at high frequencies.

Benefits

1. High Q-Factor (Quality Factor)
2. Ceramic body and wire wound construction provide high SRFs
3. Low DC resistance design
4. High Current Handling
5. Can maintain excellent thermal stability at different temperatures

Applications

1. Industrial and Medical Equipmen: RFID systems and medical imaging equipment.
2. Data Centers
3. Networking
4. Base Station
5. Consumer Electronics
6. Security system

Product Information

Series	Size Code (JIS/EIA)	Inductance (nH)
BWCS	0603/0201	1 ~ 470
	1005/0402	
	1608/0603	
	2012/0805	
	2520/1008	
	4938/1812	



BWCS00161008 Series Specification

1 Scope: This specification applies to Wire Wound Ceramic Chip Inductors

2 Part Numbering:

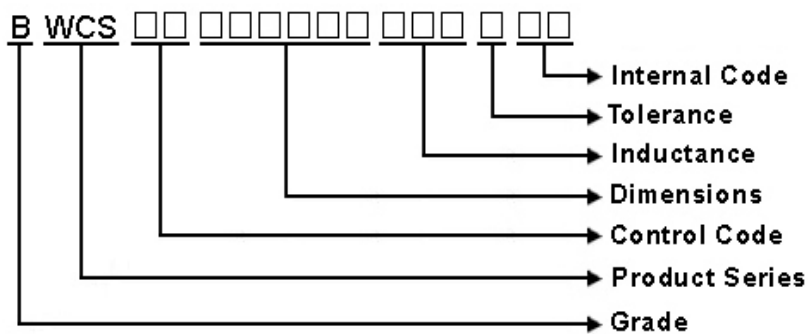

3 Rating:

Operating Temperature: - 40°C ~ 125°C
(Including self - temperature rise)

Storage Temperature: - 40°C ~ 125°C
(The storage temperature range is for after the assembly)

4 Marking:

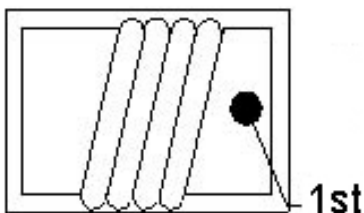

EX:BWCS001610086N8J00

Marking:1st→RED

5 Standard Testing Condition

	Unless otherwise specified	In case of doubt
Temperature	Ordinary Temperature(15 to 35°C)	20 to 30°C
Humidity	Ordinary Humidity(25 to 85% RH)	50 to 80 %RH

BWCS00161008 Series Specification

6 Configuration and Dimensions and Unit Weight:

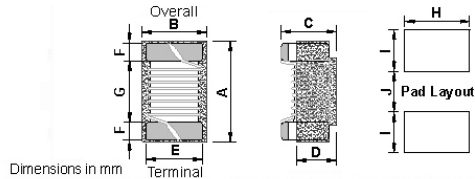

Dimensions in mm

TYPE	A	B	C	D	E	F	G	H	I	J
161008	1.6 ^{+0.2} _{-0.1}	1.02±0.1	0.82 ^{+0.2} _{-0.1}	0.51	0.76	0.33	0.86	1.02	0.64	0.64

Net Weight (grms)

SIZE CODE	Net Weight (grms)
161008	0.00335 (typ.)

7 Electrical Characteristics:

Part No.	Inductance (nH)	L/Q Test Freq. (MHz)	Q Min.	SRF (MHz)Min.	RDC (Ω)Max.	I _{rms} (mA)Max.	Tolerance	Color Code 1st
BWCS001610081N6□00	1.6	250/250	24	12500	0.03	700	K,J,B	RED
BWCS001610081N8□00	1.8	250/250	16	12500	0.045	700	K,J,B	BLK
BWCS001610082N2□00	2.2	250/250	13	12500	0.25	700	K,J,B	YEL
BWCS001610083N3□00	3.3	250/250	35	5900	0.045	700	K,J,H,G	BLU
BWCS001610083N6□00	3.6	250/250	22	5900	0.063	700	K,J,H,G	RED
BWCS001610083N9□00	3.9	250/250	22	6900	0.08	700	K,J,H,G	BRN
BWCS001610084N3□00	4.3	250/250	22	5900	0.063	700	K,J,H,G	ORN
BWCS001610084N7□00	4.7	250/250	20	5800	0.116	700	K,J,H,G	VIO
BWCS001610085N1□00	5.1	250/250	20	5700	0.14	700	K,J,H,G	GRN
BWCS001610085N6□00	5.6	250/250	20	5800	0.17	700	K,J,H,G	YEL
BWCS001610086N3□00	6.3	250/250	20	5700	0.14	700	K,J,H,G	WHT
BWCS001610086N8□00	6.8	250/250	27	5800	0.11	700	K,J,H,G	RED
BWCS001610087N5□00	7.5	250/250	28	4800	0.106	700	K,J,H,G	BRN
BWCS001610088N2□00	8.2	250/250	28	4700	0.109	700	K,J,H,G	WHT
BWCS001610088N7□00	8.7	250/250	28	4600	0.109	700	K,J,H,G	YEL
BWCS001610089N1□00	9.1	250/250	28	4800	0.12	700	K,J,H,G	VIO
BWCS001610089N5□00	9.5	250/250	28	5400	0.135	700	K,J,H,G	BLU
BWCS0016100810N□00	10	250/250	31	4800	0.13	700	K,J,H,G	ORN
BWCS0016100811N□00	11	250/250	33	4000	0.086	700	K,J,H,G	GRY
BWCS0016100812N□00	12	250/250	35	4000	0.13	700	K,J,H,G	YEL
BWCS0016100813N□00	13	250/250	30	4000	0.16	700	K,J,H,G	BLK
BWCS0016100815N□00	15	250/250	35	4000	0.17	700	K,J,H,G	GRN
BWCS0016100816N□00	16	250/250	34	3300	0.104	700	K,J,H,G	WHT
BWCS0016100818N□00	18	250/250	35	3100	0.17	700	K,J,H,G	BLU
BWCS0016100820N□00	20	250/250	38	3000	0.19	700	K,J,H,G	RED

NOTE: □-tolerance B=±0.1nH / G=±2% / H=±3% / J=±5% / K=±10%

1. Operating temperature range - 4 0°C ~ 1 2 5°C (Including self - temperature rise)
2. I_{rms} for a 15°C temperature rise from 25°C ambient.
3. L/Q Test OSC @200mV.

BWCS00161008 Series Specification

Part No.	Inductance (nH)	L/Q Test Freq. (MHz)	Q Min.	SRF (MHz)Min.	RDC (Ω)Max.	Irms (mA)Max.	Tolerance	Color Code 1st
BWCS0016100822N□00	22	250/250	38	3000	0.19	700	K,J,H,G	VIO
BWCS0016100823N□00	23	250/250	38	2850	0.19	700	K,J,H,G	ORN
BWCS0016100824N□00	24	250/250	37	2650	0.135	700	K,J,H,G	BLK
BWCS0016100827N□00	27	250/250	40	2800	0.22	600	K,J,H,G	GRY
BWCS0016100830N□00	30	250/250	37	2250	0.144	600	K,J,H,G	BRN
BWCS0016100833N□00	33	250/250	40	2300	0.22	600	K,J,H,G	WHT
BWCS0016100836N□00	36	250/250	38	2080	0.25	600	K,J,H,G	RED
BWCS0016100839N□00	39	250/250	40	2200	0.25	600	K,J,H,G	BLK
BWCS0016100843N□00	43	250/250	39	2000	0.28	600	K,J,H,G	ORN
BWCS0016100847N□00	47	200/200	38	2000	0.28	600	K,J,H,G	BRN
BWCS0016100851N□00	51	200/200	38	1900	0.31	600	K,J,H,G	BRN
BWCS0016100856N□00	56	200/200	38	1900	0.31	600	K,J,H,G	RED
BWCS0016100868N□00	68	200/200	37	1700	0.34	600	K,J,H,G	ORN
BWCS0016100872N□00	72	150/150	34	1700	0.49	400	K,J,H,G	YEL
BWCS0016100882N□00	82	150/150	34	1700	0.54	400	K,J,H,G	GRN
BWCS0016100891N□00	91	150/150	34	1400	0.58	400	K,J,H,G	BLK
BWCS00161008R10□00	100	150/150	34	1400	0.58	400	K,J,H,G	BLU
BWCS00161008R11□00	110	150/150	32	1350	0.61	300	K,J,H,G	VIO
BWCS00161008R12□00	120	150/150	32	1300	0.75	300	K,J,H,G	GRY
BWCS00161008R15□00	150	150/150	28	990	0.92	280	K,J,H,G	WHT
BWCS00161008R16□00	160	100/100	25	990	1.25	240	K,J,H,G	YEL
BWCS00161008R18□00	180	100/100	25	990	1.25	240	K,J,H,G	BLK
BWCS00161008R20□00	200	100/100	25	900	2.1	200	K,J,H,G	RED
BWCS00161008R21□00	210	100/100	27	895	2.06	200	K,J,H,G	GRY
BWCS00161008R22□00	220	100/100	25	900	2.1	200	K,J,H,G	BRN
BWCS00161008R24□00	240	100/100	25	900	2.2	200	K,J,H,G	GRN
BWCS00161008R25□00	250	100/100	25	822	3.55	120	K,J,H,G	VIO
BWCS00161008R27□00	270	100/100	24	900	2.8	170	K,J,H,G	RED
BWCS00161008R33□00	330	100/100	25	900	3.89	100	K,J,H,G	ORN
BWCS00161008R39□00	390	100/100	25	900	4.35	100	K,J,H,G	YEL
BWCS00161008R47□00	470	100/100	25	500	4.5	100	K,J,H,G	GRN
BWCS00161008R56□00	560	100/100	23	460	4.7	90	K,J,H,G	BLU

NOTE: □-tolerance B=±0.1nH / G=±2% / H=±3% / J=±5% / K=±10%

1. Operating temperature range - 4 0°C ~ 1 2 5°C (Including self - temperature rise)

2. Irms for a 15°C temperature rise from 25°C ambient.

3. L/Q Test OSC @200mV.

BWCS00161008 Series Specification

8 BWCS00161008 Series
8.1 Construction:

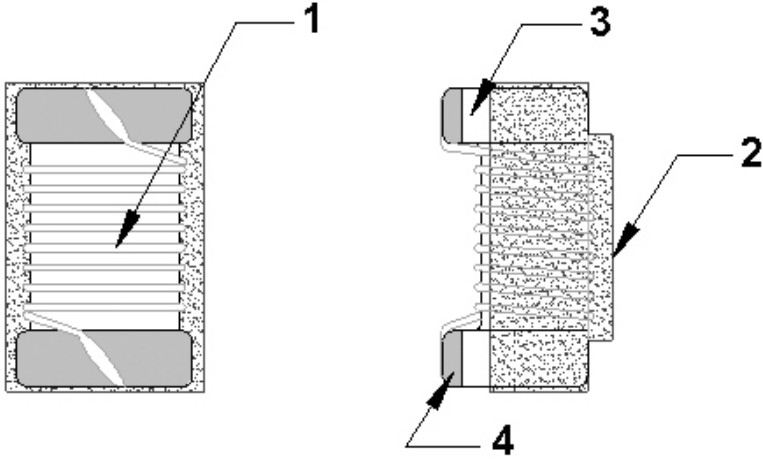

8.2 Material List:

NO	PART	MATERIAL
1	WIRE	COPPER 180
2	EPOXY	UV GLUE
3	CORE	CERAMIC
4	TERMINAL	Ag/Cu/Ni/Sn

BWCS00161008 Series Specification

9 Reliability Of Ceramic Wire Wound Chip Inductor/CERAMIC SERIES

1-1.Environmental Performance

No	Item	Specification	Test Method		
1-1-1	Temperature Cycle	Appearance: No Damage Inductance: within $\pm 10\%$ of initial value Q change: within $\pm 30\%$ of initial value	One cycle:		
			Step	Temperature ($^{\circ}\text{C}$)	Time (min)
			1	-40 \pm 3	30
			2	25 \pm 2	15
			3	125 \pm 3	30
4	25 \pm 2	15			
			Total: 5 cycles Measured After Exposure in The Room Condition For 1hrs		
1-1-2	High Temperature Resistance		Temperature: 125 \pm 3 $^{\circ}\text{C}$ Time: 1000Hrs Measured After Exposure In The Room Condition For 1Hrs		
1-1-3	Low Temperature Resistance		Temperature: -40 \pm 3 $^{\circ}\text{C}$ Time: 1000Hrs Measured After Exposure In The Room Condition For 1Hrs		
1-1-4	Humidity Load Life	There should be no evidence of short or open circle	Temperature: 40 \pm 2 $^{\circ}\text{C}$ Relative Humidity: 90~95% Load: Allowed DC Current Time: 96Hrs		

1-2.Mechanical Performance

No	Item	Specification	Test Method
1-2-1	Vibration Test (Low Frequency)	1.Appearance: No Damage 2.Inductance: within $\pm 10\%$ of initial value 3.Q change: within $\pm 30\%$ of initial value	1. Test device shall be soldered on the substrate. 2. Oscillation frequency: 10 to 55 to 10Hz for 1min. 3. Amplitude: 1.5mm 4. Time: 2hrs for each axis(X, Y & Z), total 6hrs
1-2-2	Resistance TO Soldering Heat	Appearance: No Damage	1. The device should be reflow soldered on PCB (peak 260 $^{\circ}\text{C}$ \pm 5 $^{\circ}\text{C}$ for 10 seconds) 2. Solder Composition: Sn/Ag3.0/Cu0.5 3. Test time: 6 minutes
1-2-3	Solder ability	The electrodes shall be at least 95% covered with new solder coating	1. Pre-Heating: 150 $^{\circ}\text{C}$, 1min. 2. Solder Composition: Sn/Ag3.0/Cu0.5 3. Solder Temperature: 245 \pm 5 $^{\circ}\text{C}$. 4. Immersion Time: 4 \pm 1 sec.
1-2-4	Component Adhesion (Push Test)	1 Lbs. For 0402 2 Lbs. For 0603 4 Lbs. For The Rest	The device should be reflow soldered (245 \pm 5 $^{\circ}\text{C}$ For 10 seconds) to a tinned copper substrate. A force gauge should be applied to the side of the component. The device must withstand a minimum force of 2 or 4 pounds without a failure of the termination attached to component

BWCS00161008 Series Specification

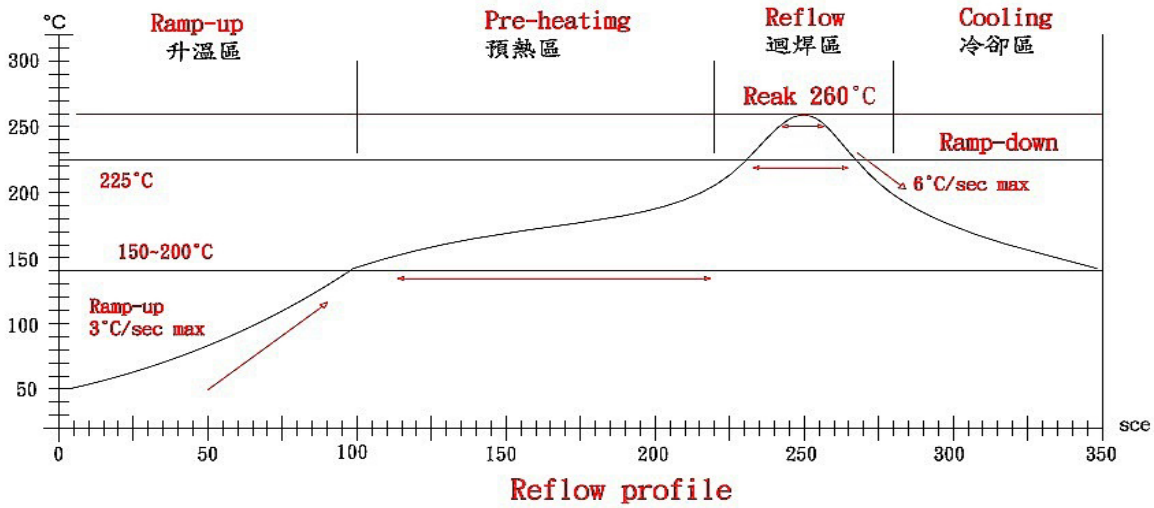

Lead-Free(LF)標準溫度分析範圍

Refer to J-STD-020C

管制項目 Item.	升温區 Ramp-up	預熱區 Pre-heating	迴焊區 Reflow	Peak Temp	冷卻區 Cooling
溫度範圍 Temp.scope	R.T ~ 150°C	150°C ~ 200°C	Above 217°C	260±5°C	Peak Temp.~150°C
標準時間 Time spec.	-	60 ~ 180 sec	60 ~ 150 sec	20 ~ 40 sec	-
實際時間 Time result	-	75 ~ 100 sec	90 ~ 120 sec	20 ~ 35 sec	-

NOTE:

- 1.Re-flow possible times : within 3 times
- 2.Nitrogen adopted is recommends while in re-flow
- 3.Products can only be soldered with reflow

BWCS00161008 Series Specification

10 Packaging:

10.1 Packaging -Cover Tape

The force for tearing off cover tape is 10 to 100 grams in the arrow direction.

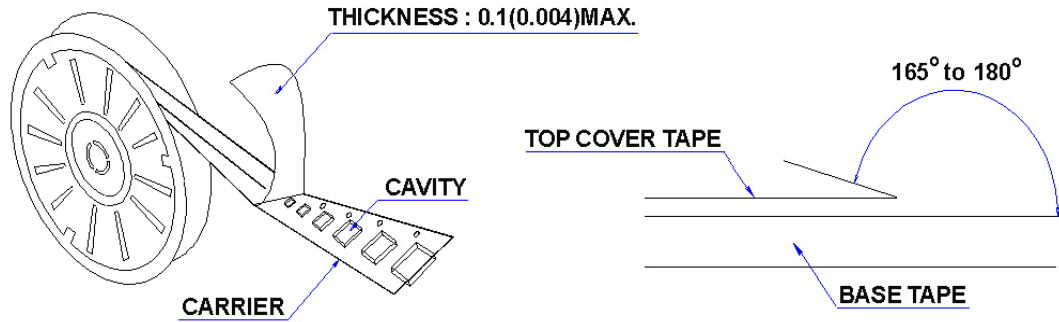

10.2 Packaging Quantity

TYPE	PCS/REEL
161008	4000

10.3 Reel Dimensions

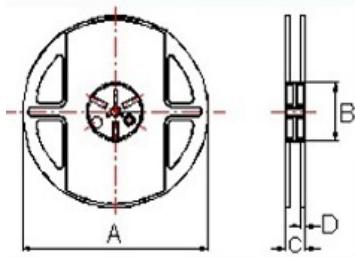

Dimensions in mm

TYPE	A	B	C	D
161008	178±1	60±0.5	12±0.5	1.5±0.5

BWCS00161008 Series Specification

10 Packaging:

10.4 Tape Dimensions in mm

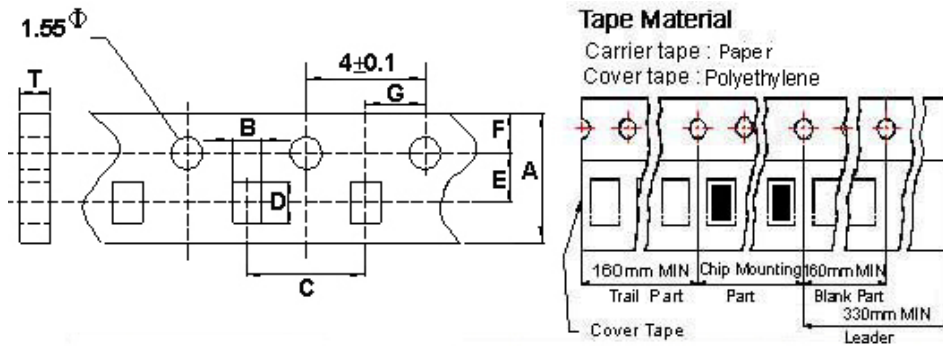

TYPE	A	B	C	D	E	F	G	T
161008	8.0	1.25	4	1.90	3.5	1.75	2	1.05

11 Recommended Land Pattern:

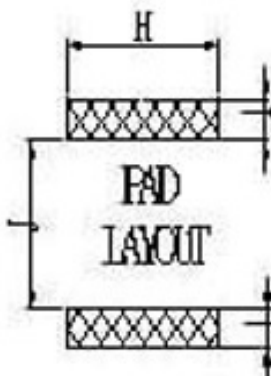

Dimensions in mm

TYPE	H(In/mm)	I(In/mm)	J(In/mm)
161008	0.04/1.02	0.025/0.64	0.025/0.64

12 Note:

- Please make sure that your product has been evaluated and confirmed against your specifications when our product is mounted to your product.
- Do not knock nor drop.
- All the items and parameters in this product specification have been prescribed on the premise that our product is used for the purpose, under the condition and in the environment agreed upon between you and us. You are requested not to use our product deviating from such agreement.
- The storage period is less than 12 months. Be sure to follow the storage conditions (Temperature: 5 to 40°C, Humidity: 10 to 75% RH or less).
If the storage period elapses, the soldering of the terminal electrodes may deteriorate.
- Do not use or store in locations where there are conditions such as gas corrosion (salt, acid, alkali, etc.).
- The moisture sensitivity level (MSL) of products is classified as level 1.

BWCS00161008 Series Specification

13 Graph:

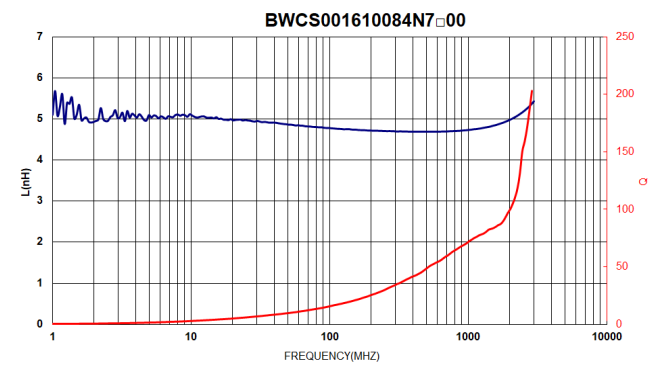
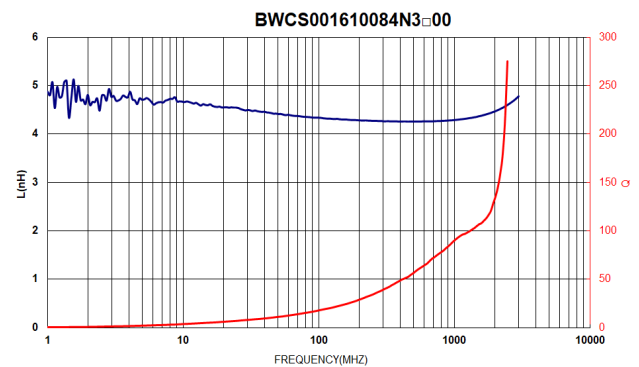
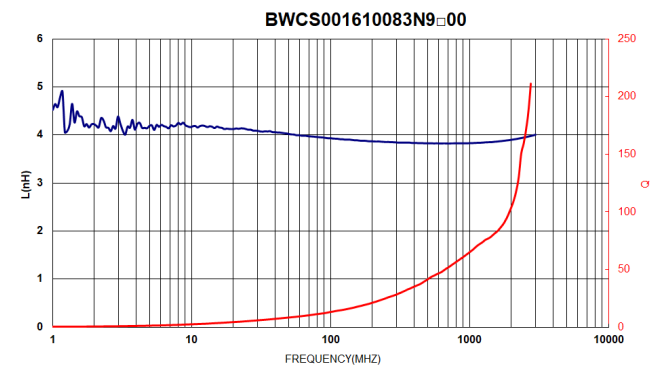
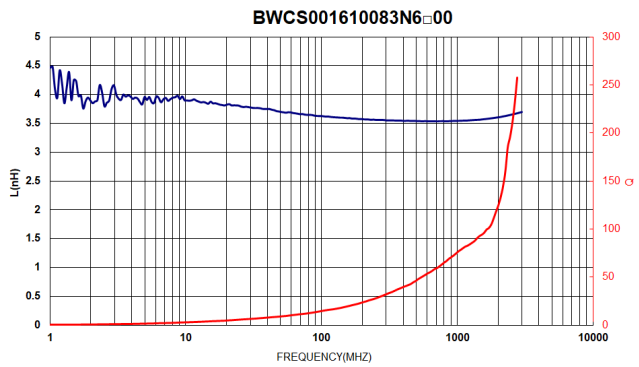
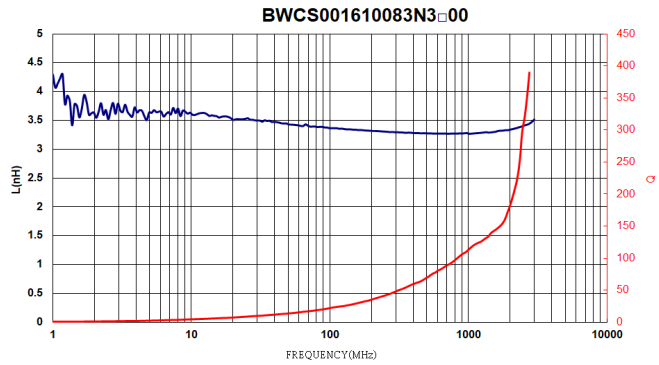
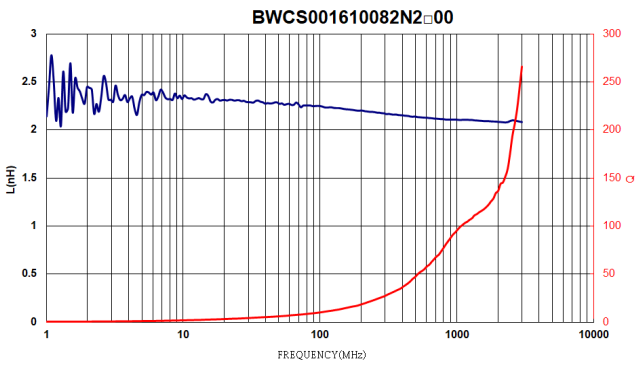
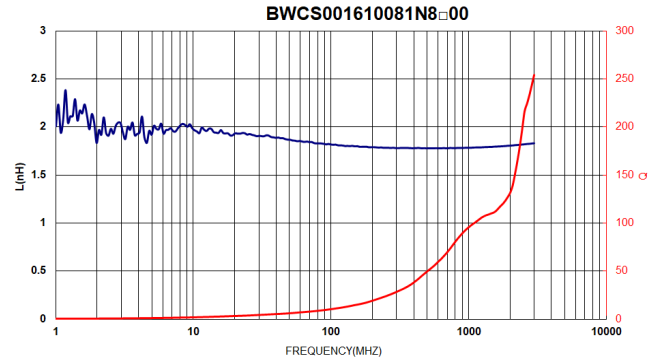
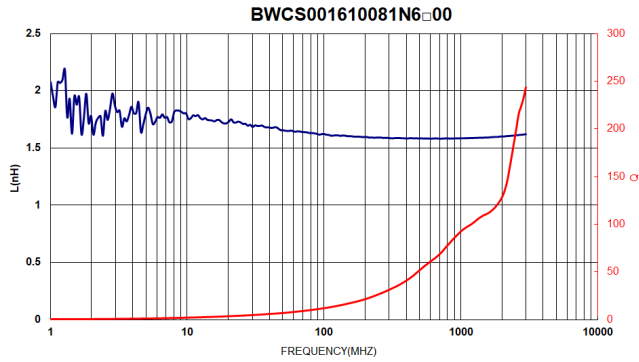

BWCS00161008 Series Specification

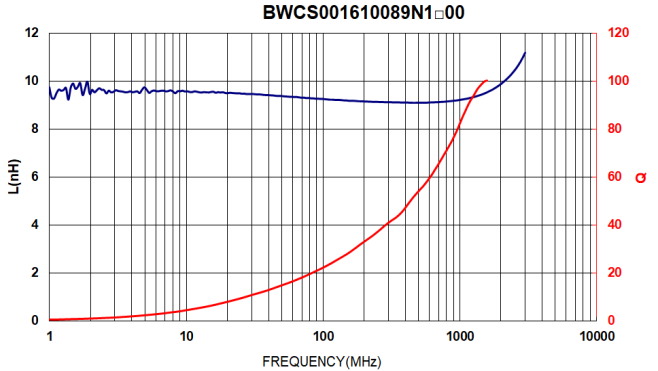
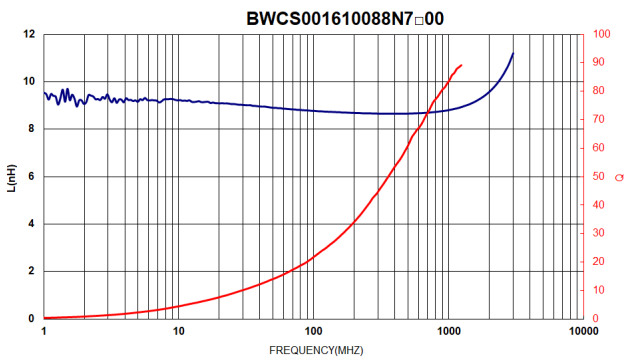
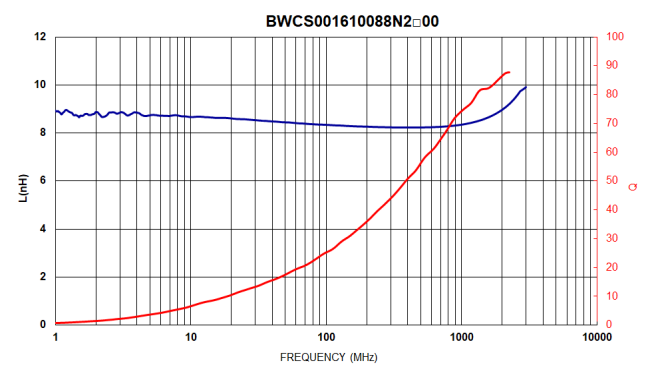
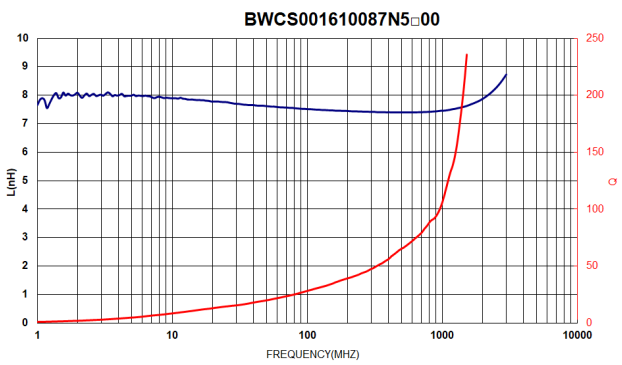
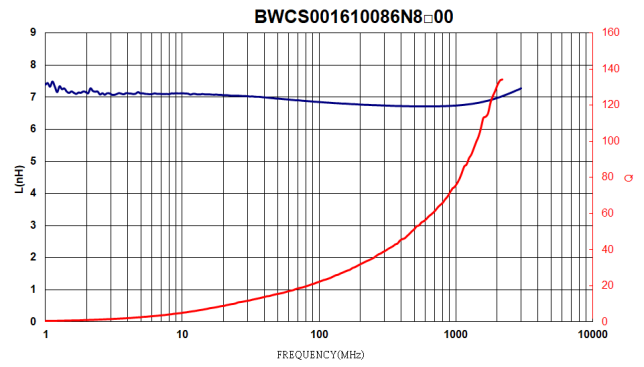
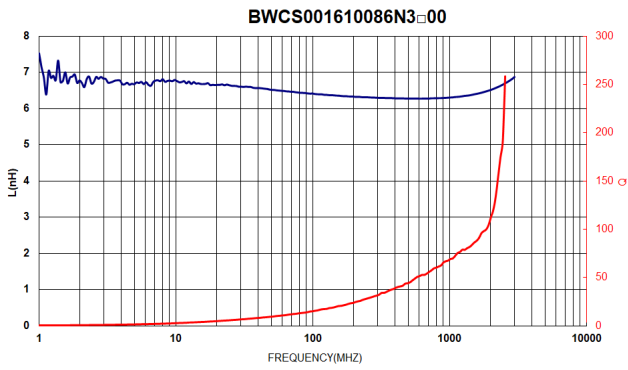
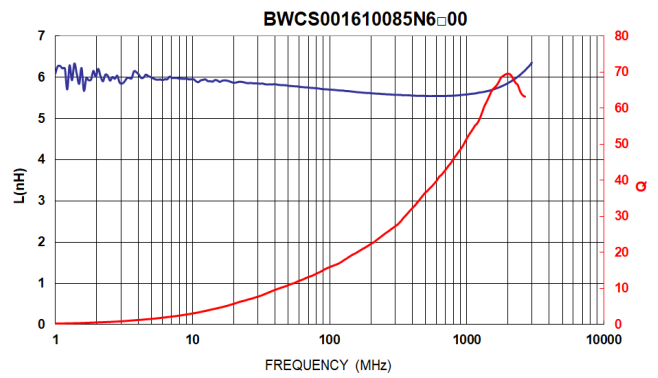
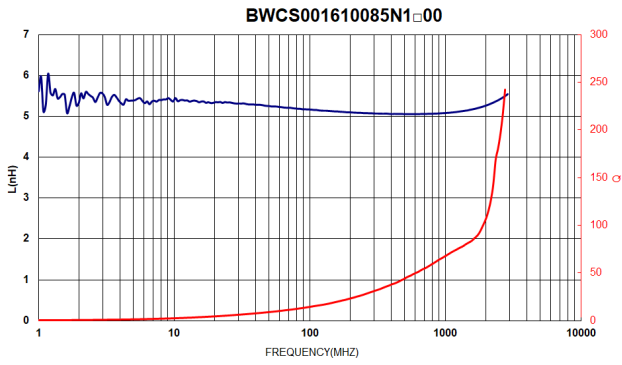

BWCS00161008 Series Specification

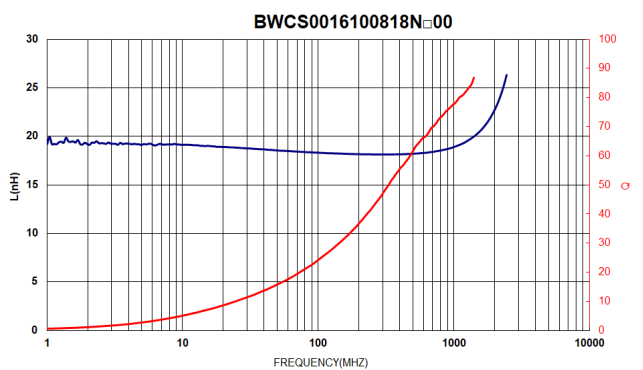
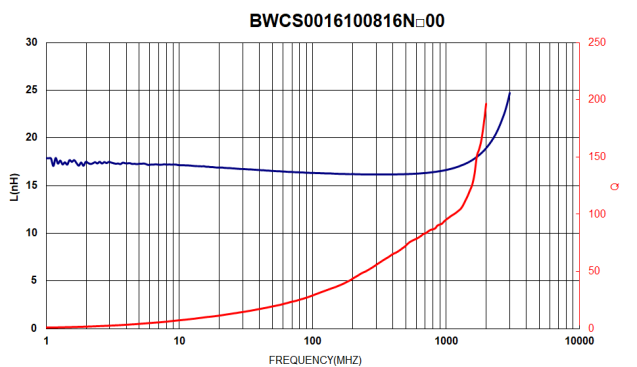
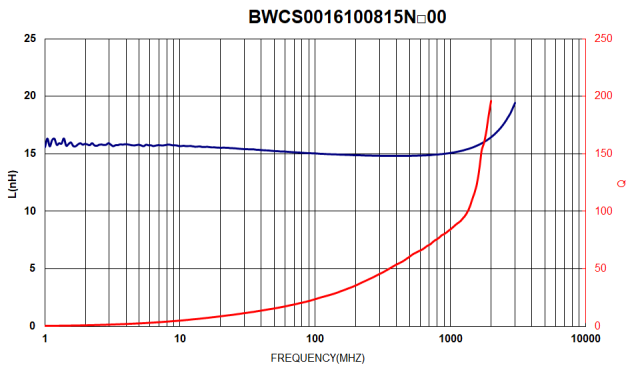
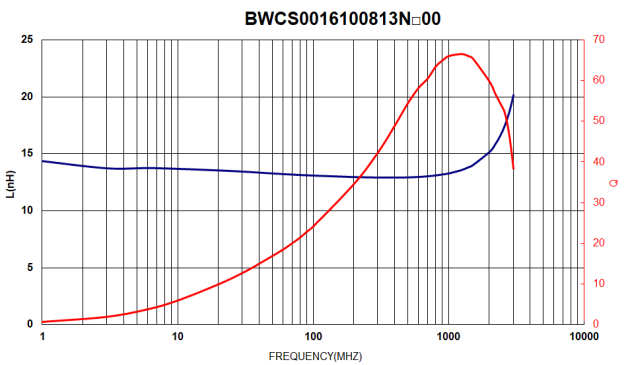
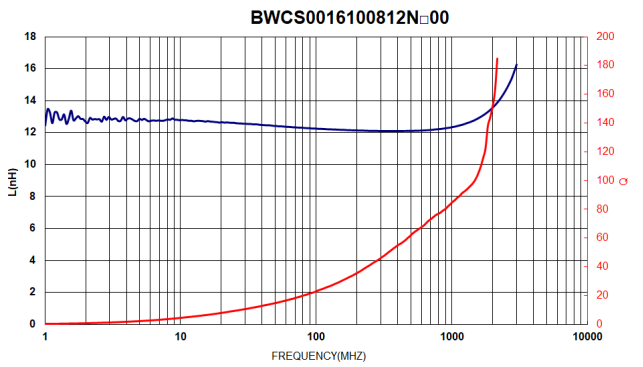
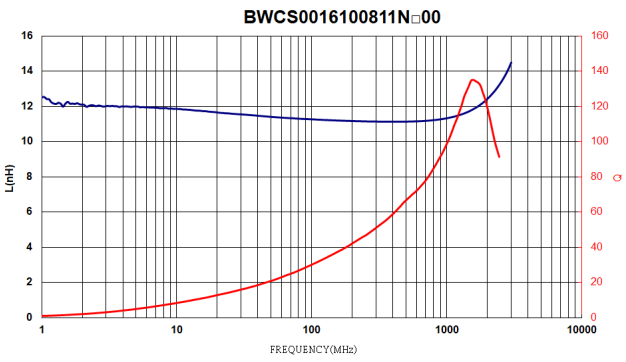
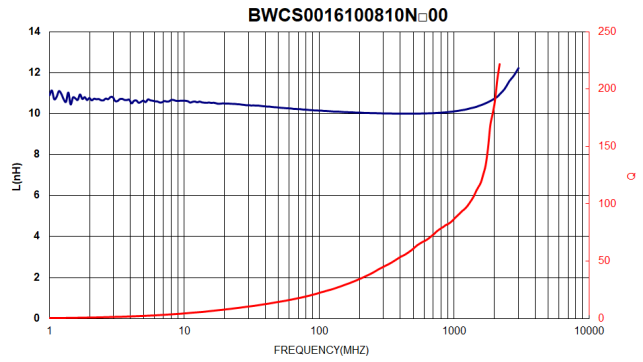
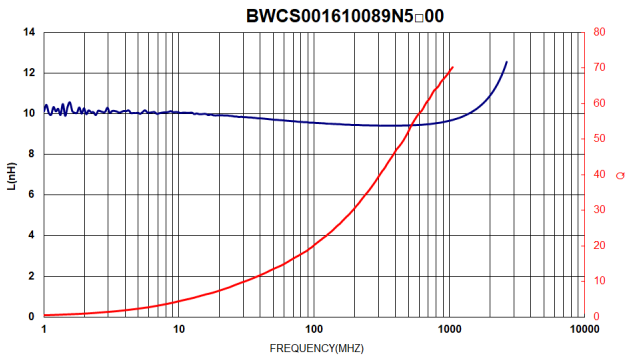

BWCS00161008 Series Specification

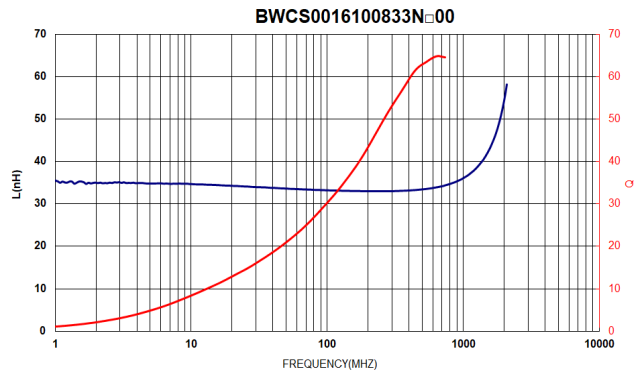
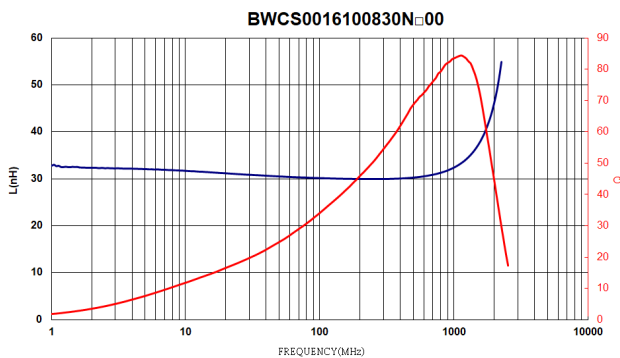
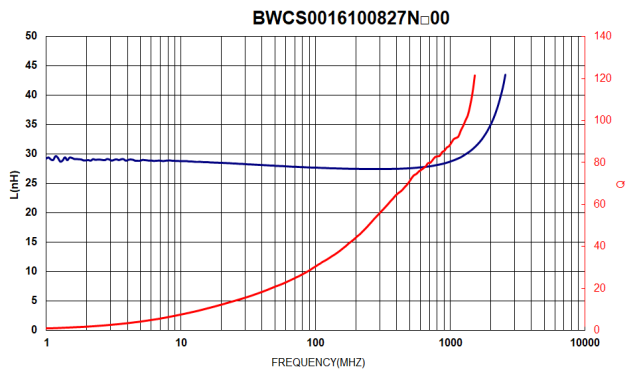
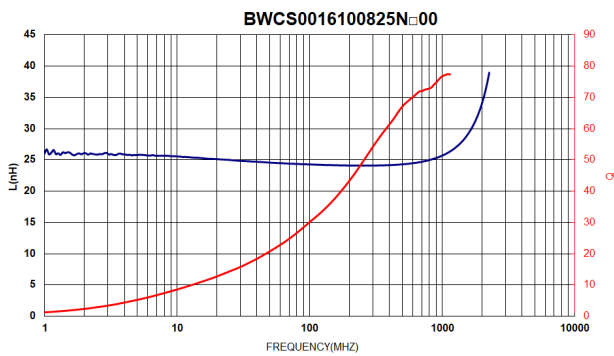
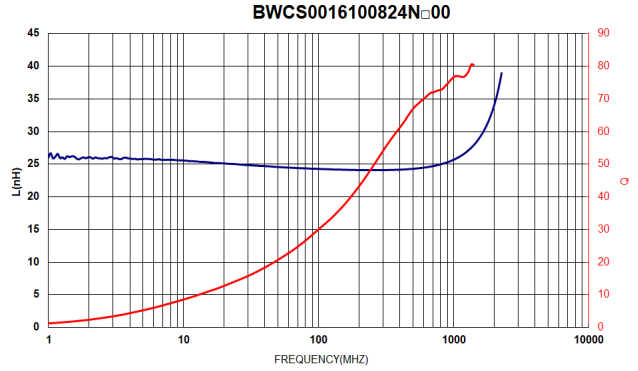
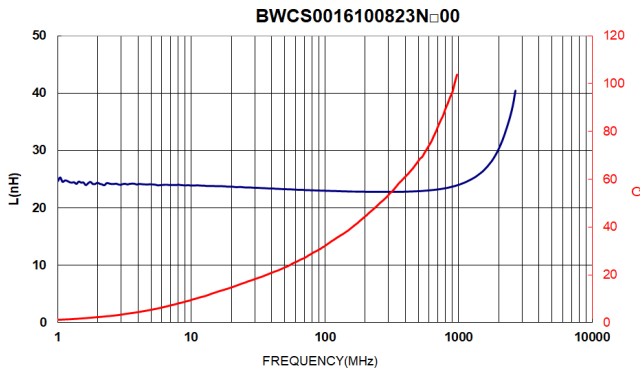
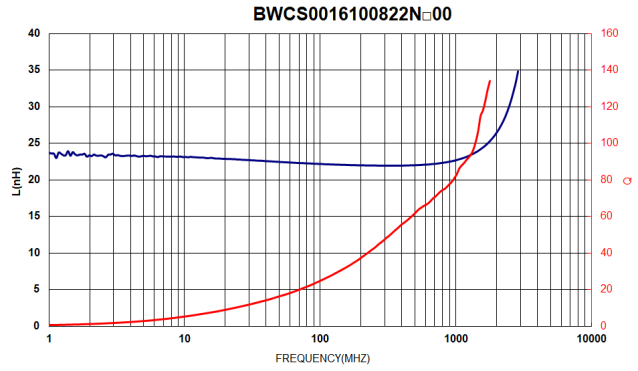
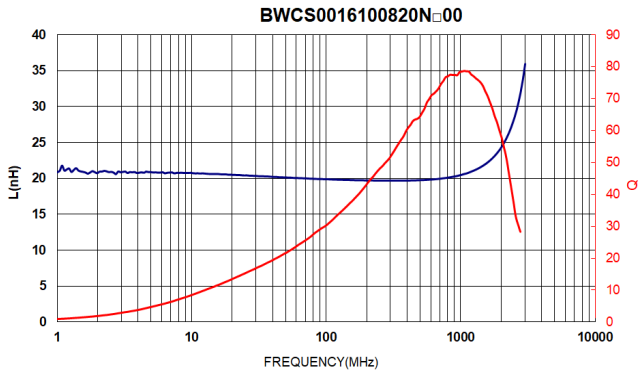

BWCS00161008 Series Specification

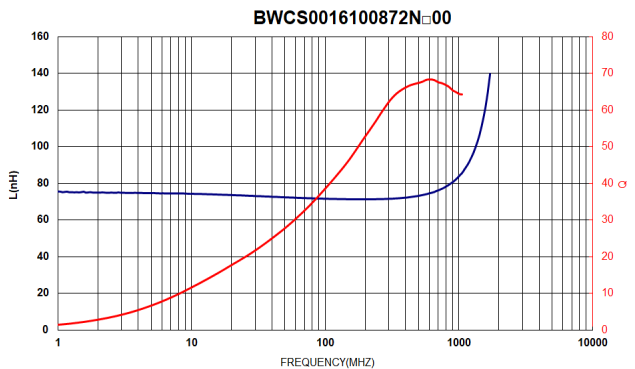
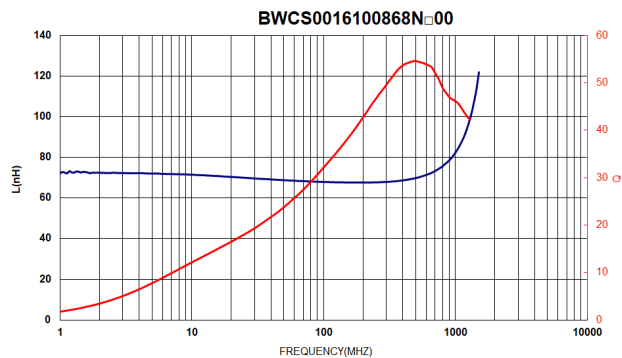
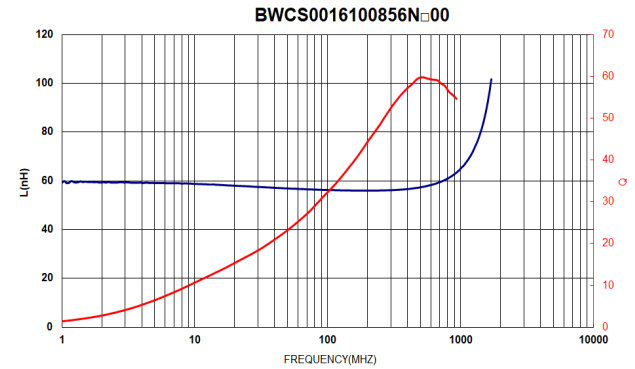
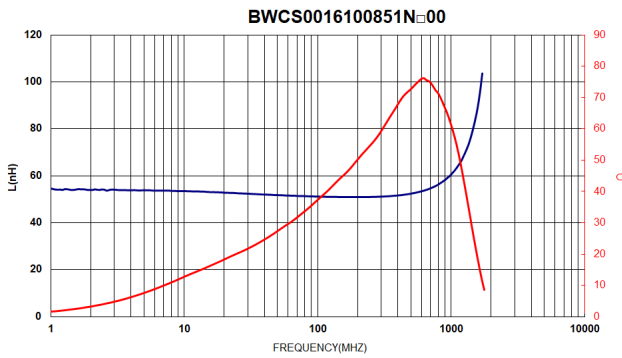
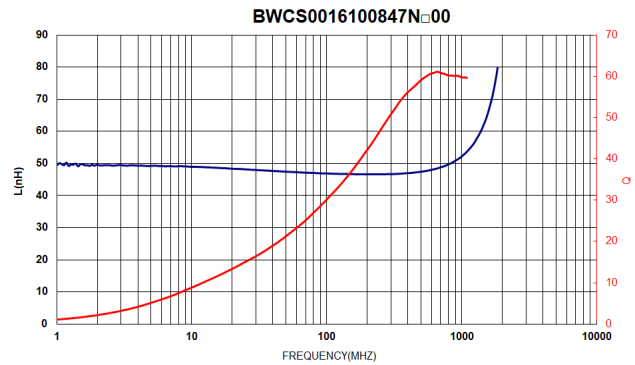
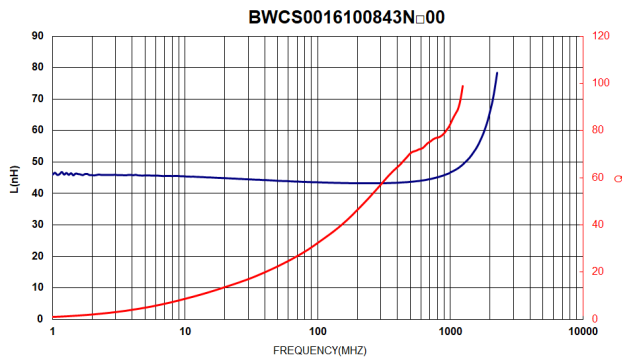
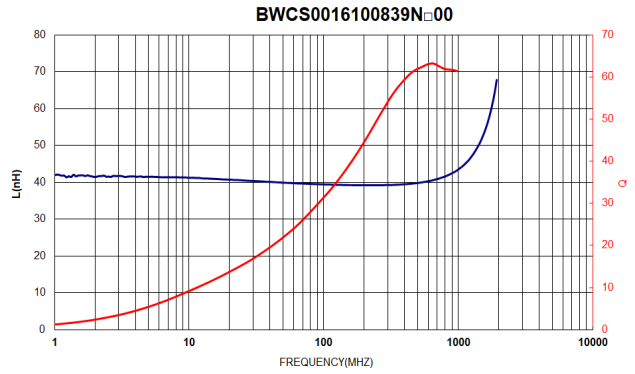
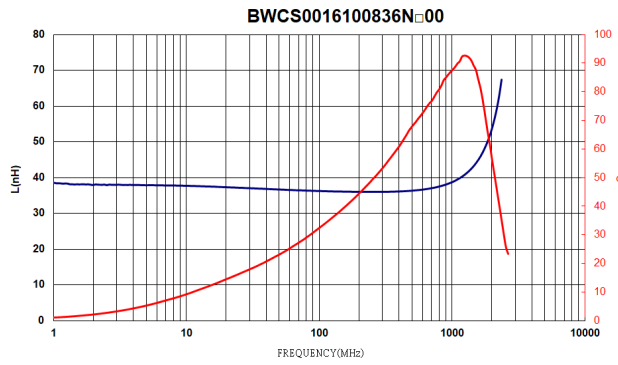

BWCS00161008 Series Specification

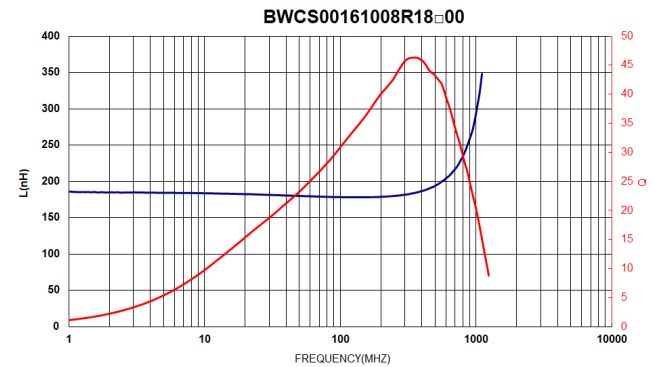
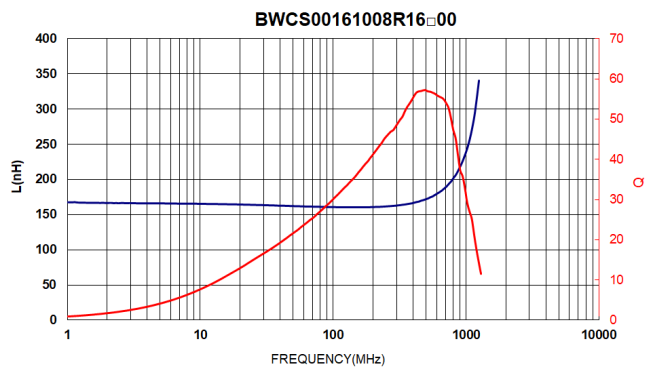
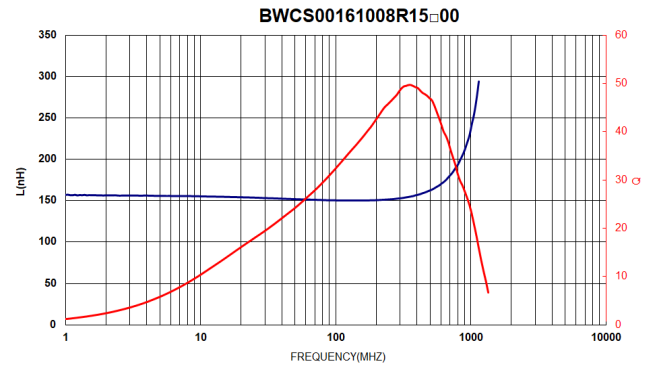
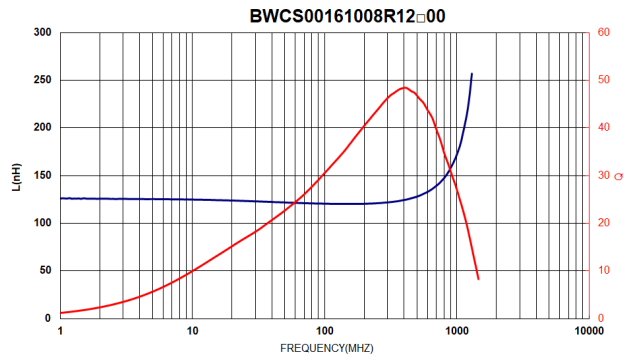
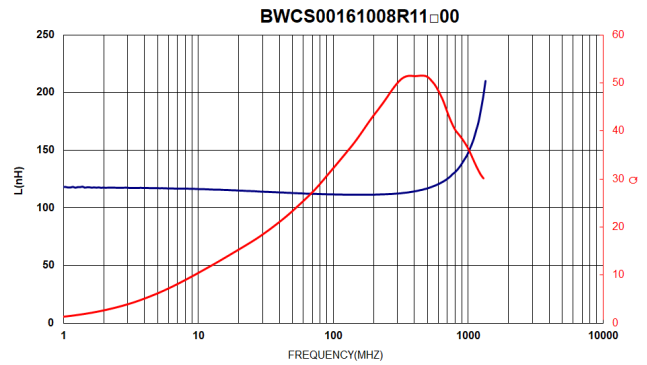
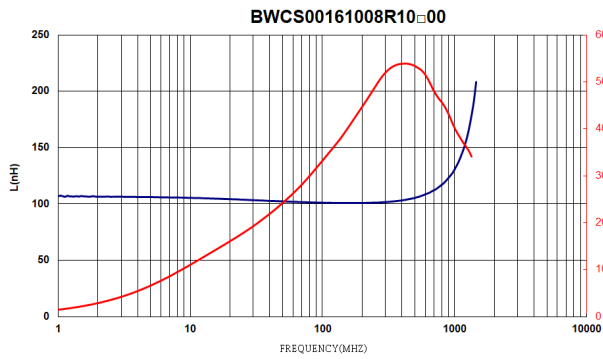
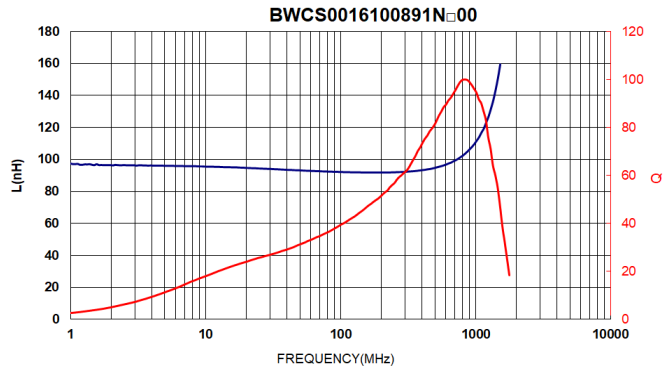
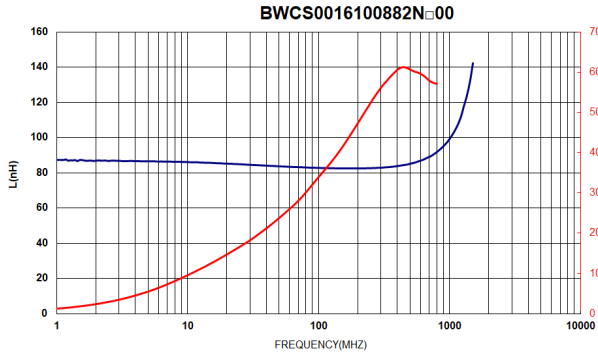

BWCS00161008 Series Specification

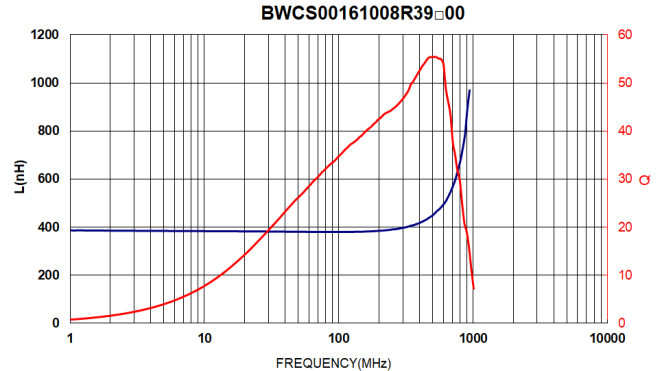
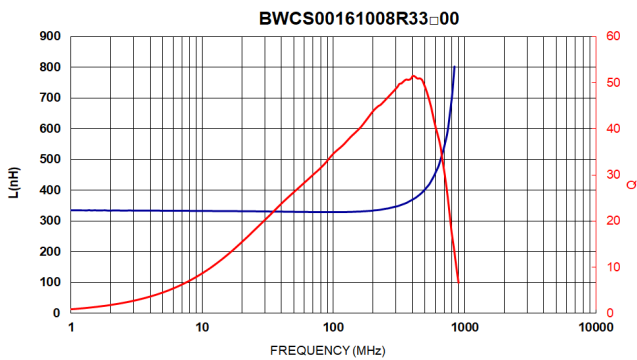
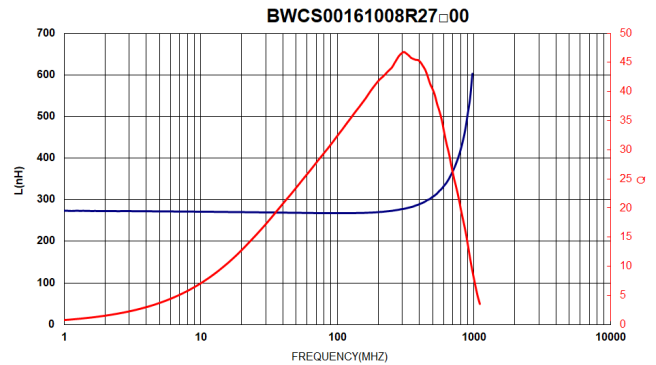
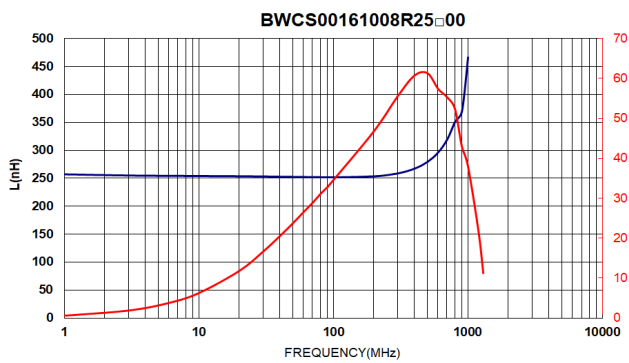
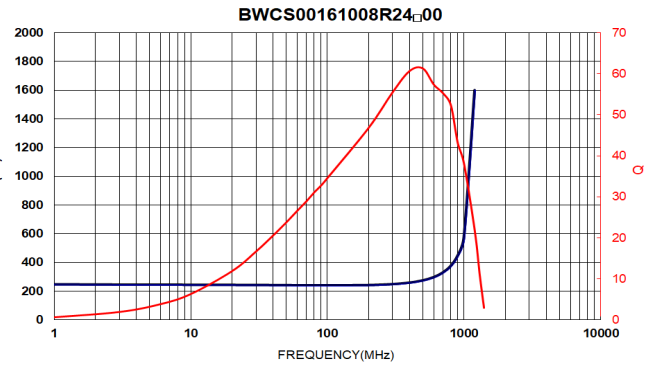
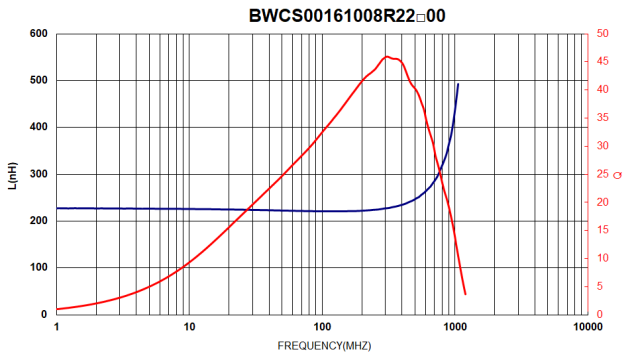
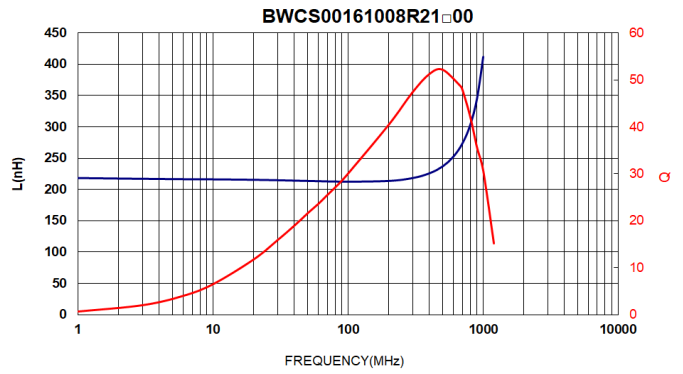
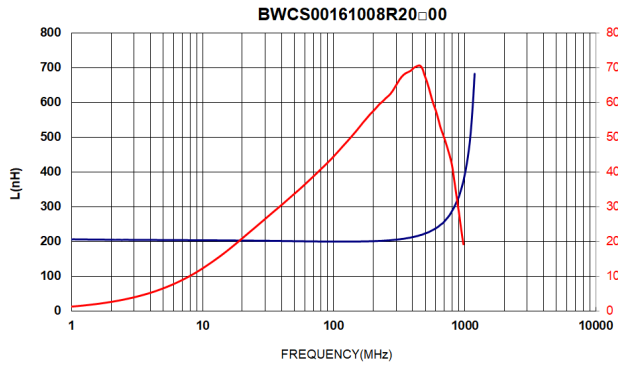

BWCS00161008 Series Specification

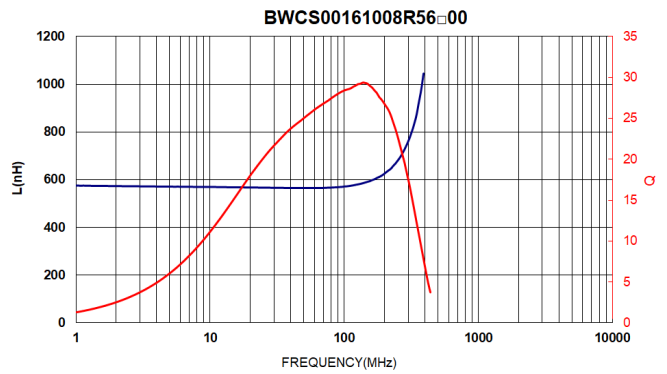
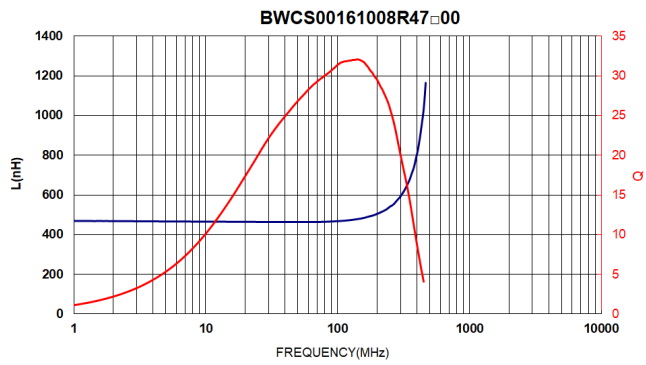

单击下面可查看定价，库存，交付和生命周期等信息

[>>CHILISIN\(奇力新\)](#)