

Description

The DMG2302U-7 is the new generation trench N-channel MOSFET has been designed to minimize the on-state resistance ($R_{DS(ON)}$) yet maintain superior switching performance, making it ideal for high efficiency power management applications

Features

- 20V, 3.0A, $R_{DS(ON)} = 37m\Omega @ V_{GS} = 4.5V$
- Improved dv/dt capability
- Fast switching
- Green Device Available

Applications

- Notebook
- Load Switch
- Power Management

V_{DSS}	20V
I_D	3.0A
$R_{DS(ON)}$	$37m\Omega @ V_{GS}=2.5V$
$R_{DS(ON)}$	$50m\Omega @ V_{GS}=4.5V$

Outline

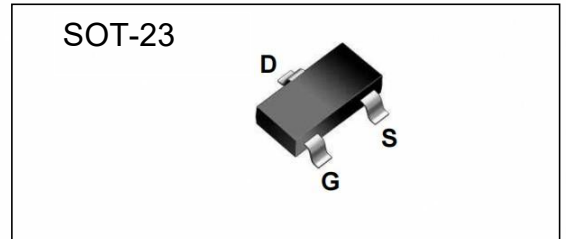

Equivalent

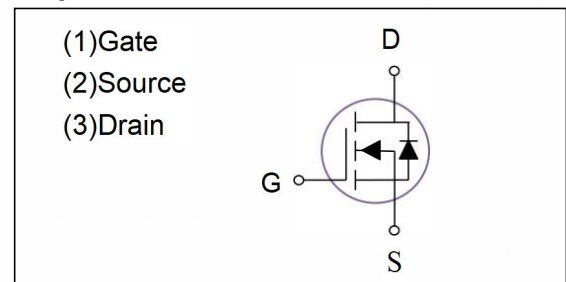

Packaging specifications

Part No.	Package	Marking	Basic ordering unit.(pcs)
DMG2302U-7	SOT-23		3000

Absolute Maximum Ratings

Parameter	Symbol	Limit	Units	
Drain-Source Voltage	V_{DS}	20	V	
Gate-Source Voltage	V_{GS}	± 12	V	
Drain Current-Continuous ^(Note2)	I_D	$T_A=25^\circ C$	3.0	A
		$T_A=70^\circ C$	2.6	A
-Pulsed ^(Note 1· Note 2)	I_{DM}	12	A	
Maximum Power Dissipation	P_D	$T_A=25^\circ C$	1.56	W
		$T_A=70^\circ C$	1	W
Operating Junction and Storage Temperature Range	T_J, T_{STG}	-55 to 150	$^\circ C$	
Thermal Resistance Junction-Ambient	$R_{\theta JA}$	80	$^\circ C / W$	

Electrical Characteristics (TC=25 °C, unless otherwise noted)

Parameter	Symbol	Test Conditions	Min	Typ	Max	Units
OFF CHARACTERISTICS						
Drain-Source Breakdown Voltage	BV_{DSS}	$V_{GS}=0V, I_D=250\mu A$	20			V
Zero Gate Voltage Drain Current	I_{DSS}	$V_{DS}=20V, V_{GS}=0V$			1	μA
Gate-Body Leakage Current	I_{GSS}	$V_{GS} = \pm 12V, V_{DS} = 0V$			± 100	nA
ON CHARACTERISTICS						
Gate Threshold Voltage	$V_{GS(th)}$	$V_{DS} = V_{GS}, I_D=250\mu A$	0.5	0.6	1.2	V
Drain-Source On-State Resistance	$R_{DS(ON)}$	$V_{GS} = 4.5V, I_D = 3A$		37	44	$m\Omega$
		$V_{GS} = 2.5V, I_D = 2A$		50	60	$m\Omega$
DYNAMIC CHARACTERISTICS <small>Note4</small>						
Input Capacitance	C_{ISS}	$V_{DS} = 10V, V_{GS} = 0V, f = 1.0MHz$		300		pF
Output Capacitance	C_{OSS}			60		pF
Reverse Transfer Capacitance	C_{RSS}			40		pF
Total Gate Charge	Q_g	$V_{DS} = 10V, I_D = 3A, V_{GS} = 4.5V$		3.5		nC
Gate-Source Charge	Q_{gs}	$V_{DS} = 10V, I_D = 3A, V_{GS} = 4.5V$		0.5		nC
Gate-Drain Charge	Q_{gd}			1.5		nC
SWITCHING CHARACTERISTICS <small>Note4</small>						
Turn-On Delay Time	$t_{D(ON)}$	$V_{DD} = 10V, I_D = 1A, V_{GS} = 4.5V, R_G = 25\Omega$		4		ns
Rise Time	t_r			10		ns
Turn-Off Delay Time	$t_{D(OFF)}$			20		ns
Fall Time	t_f			8		ns
DRAIN-SOURCE DIODE CHARACTERISTICS AND MAXIMUM RATINGS						
Diode Forward Voltage	V_{SD}	$V_{GS}=0V, I_S=3A$			1	V

Notes:

- 1、Pulse Test Width < 300us, Duty Cycle < 2%
- 2、Drain current limited by maximum junction temperature.
- 3、Guaranteed by design, not subject to production testing.

Typical Performance Characteristics

Fig.1 Continuous Drain Current vs. TC

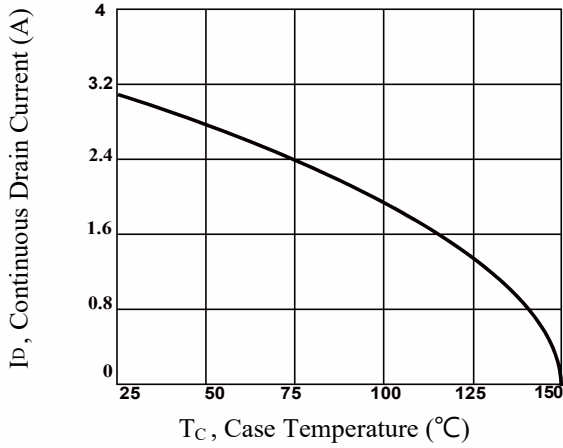

Fig.2 Normalized RDSON vs. TJ

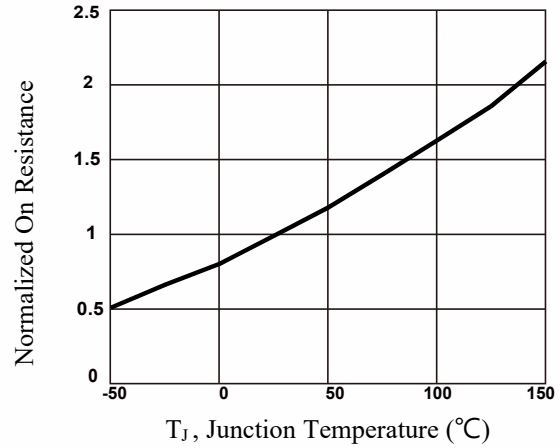

Fig.3 Normalized Vth vs. TJ

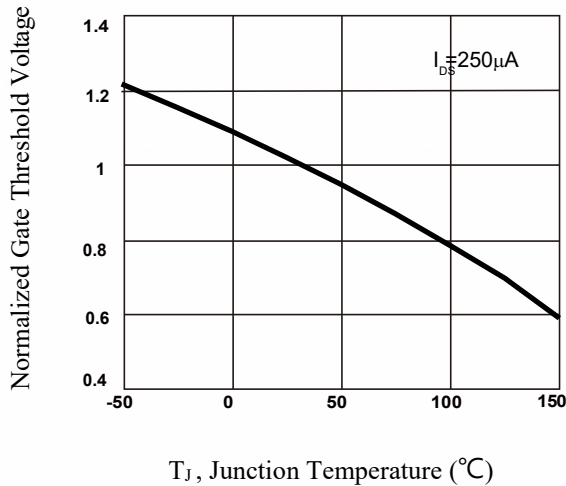

Fig.4 Gate Charge Waveform

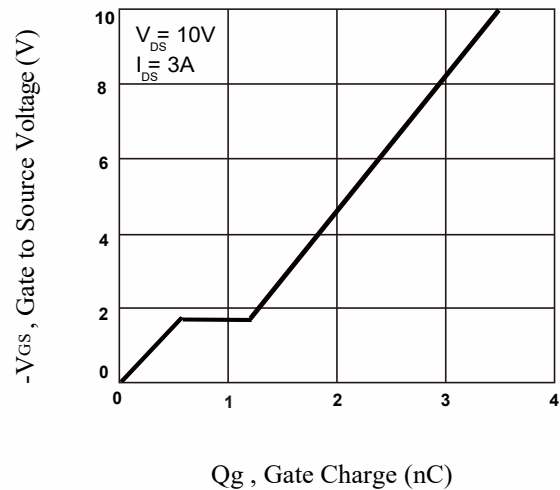

Fig.5 Typical Output Characteristics

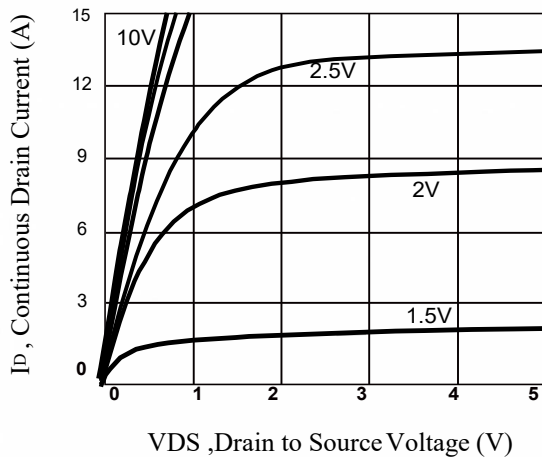

Fig.6 Capacitance

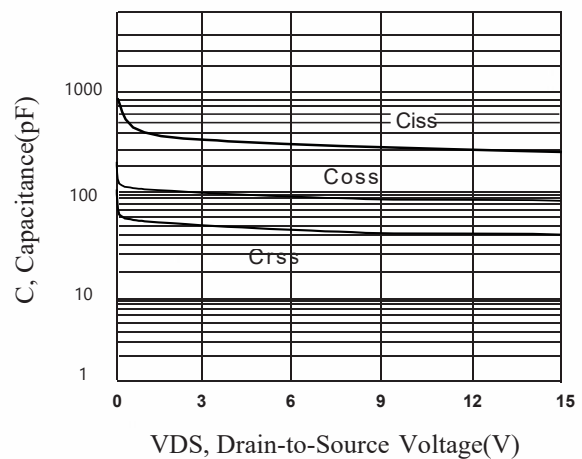

Fig.7 Turn-On Resistance vs. ID

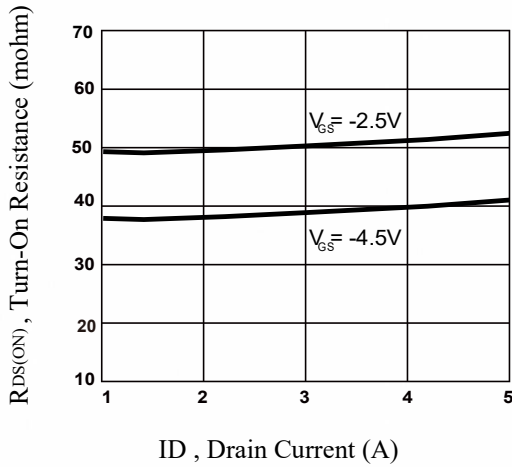

Fig.8 Typical Source-Drain Diode Forward Voltage

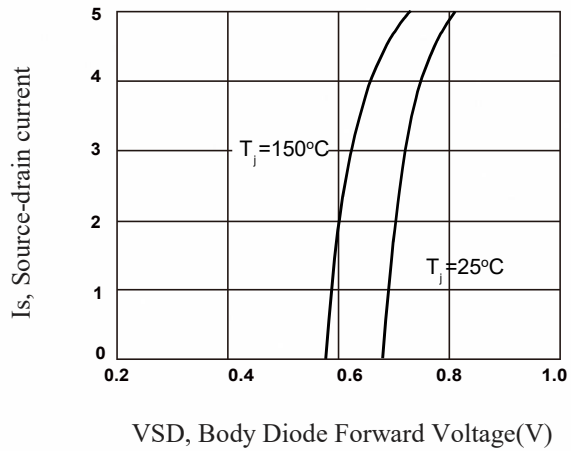

Fig.9 Normalized Transient Impedance

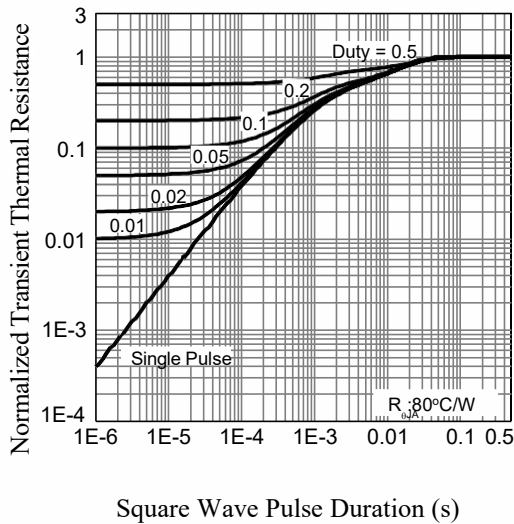

Fig.10 Maximum Safe Operation Area

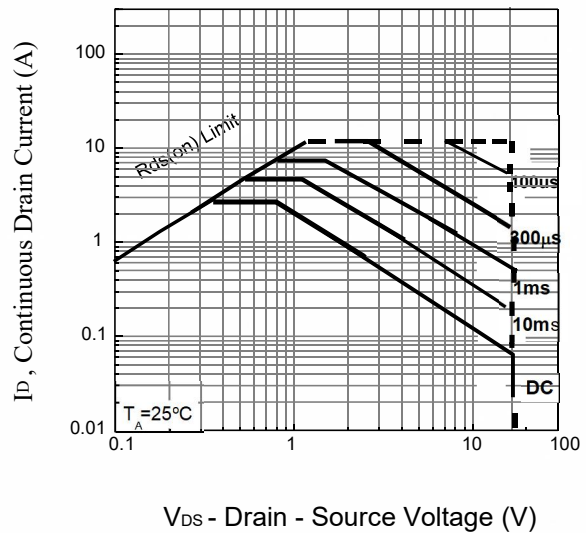

Figure11a. Switching Test Circuit

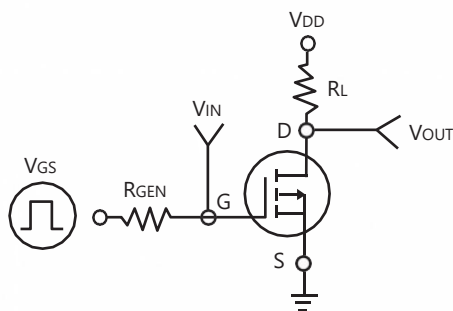
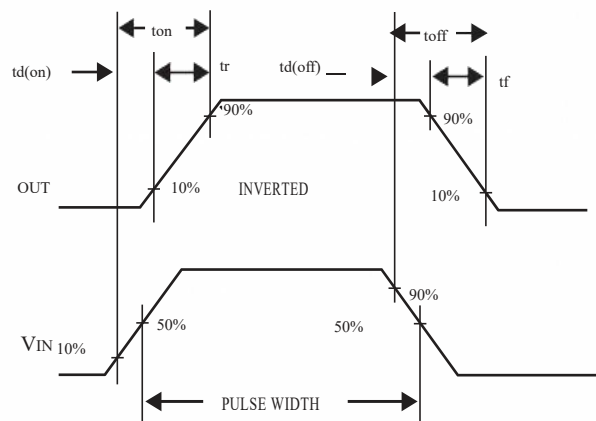
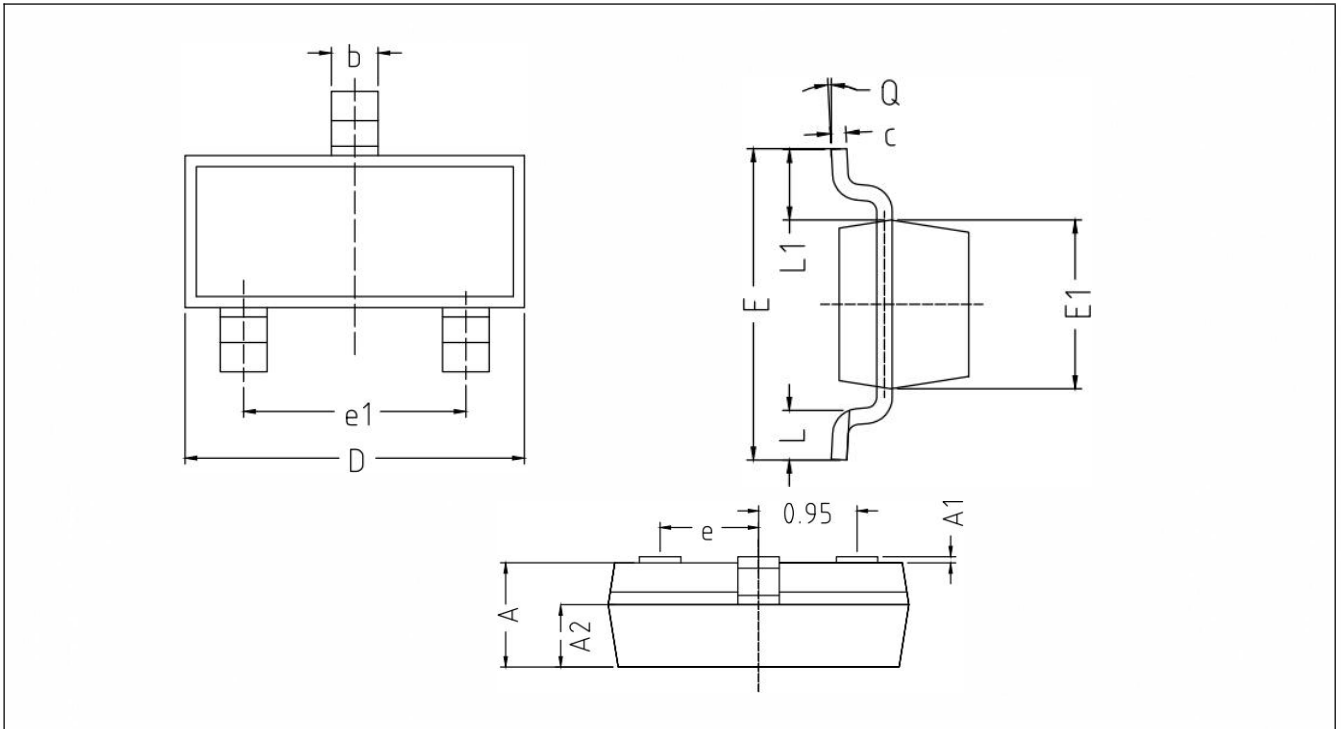

Figure 11b. Switching Waveforms



SOT-23 Package Information



SOT-23 PKG

SYMBOL	MIN	TYP	MAX
A	0.950	1.000	1.050
A1	0.000	0.050	0.100
A2	0.570	0.600	0.630
b	0.350	0.400	0.450
c	0.100	0.130	0.200
D	2.800	2.900	3.000
E	2.250	2.400	2.550
E1	1.200	1.300	1.400
e	0.950 TYP		
e1	1.800	1.900	2.000
L	0.290	0.390	0.490
L1	0.550REF		
Q	0°	4°	8°

NOTICE

NKGL reserves the to make modifications,enhancements,improvements,corrections or other changes without further notice to any product herein.NKGL does not assume any liability arising out of the application or use of any product described herein.